



AGNICO EAGLE

MEADOWBANK GOLD MINE

WASTE ROCK AND TAILINGS MANAGEMENT PLAN

V14

FEBRUARY 2024



EXECUTIVE SUMMARY

Agnico Eagle Mines Ltd. Meadowbank Division (AEM) is operating the Meadowbank Gold Mine (the Mine), located on Inuit-owned surface lands in the Kivalliq region approximately 70 km north of the Hamlet of Baker Lake, Nunavut. The Mine is subject to the terms and conditions of both the Project Certificate issued in accordance with the Nunavut Land Claims Agreement Article 12.5.12 on December 30, 2006, and the Nunavut Water Board Water License No. 2AM-MEA1530 issued in May 2020. This report presents the annual update of the Waste Rock and Tailings Management Plan for Meadowbank mine.

The Meadowbank Mine consists of several gold-bearing deposits: Vault, Portage and Goose Island. Prior to the beginning of mining a series of dikes were built to isolate the mining activities from neighbouring lakes.

Waste rock from the Portage and Goose Island Pits is stored in the Portage Rock Storage Facility (Portage RSF), and in the Portage Pit as infill. The Portage RSF was constructed in a way to minimize the disturbed area and is capped with a 4m layer of non-acid-generating rock to limit the depth of the yearly active layer as part of progressive reclamation. This control strategy is designed to minimize the onset of oxidation and the subsequent generation of acid rock drainage through freeze control of the waste rock as a result of permafrost encapsulation and capping with an insulating convective layer of Non-Potentially Acid Generating (NPAG) rock. The waste rock below the capping layer is expected to freeze, preventing acid rock drainage (ARD) in the long term. Thermistors currently installed in the Portage RSF indicate that freezing is occurring.

Mining commenced at the Vault Pit mining operation in 2014 and concluded in June 2019. Waste rock from the Vault Pit, Phaser Pit, and BB-Phaser Pit mining operation is stored in the Vault Waste Rock Storage Facility (Vault RSF). Geochemical predictions indicate that a capping layer will not be required at the Vault RSF as the majority of waste rock produced is NPAG. To date, through the ARD testing program, it has been determined that approximately 85.5 % of the waste rock generated is NPAG. As a precaution, Potentially Acid Generating (PAG) waste rock was placed in the middle of the Vault RSF and this material will be covered with at least 4m of NPAG to minimize any generation of ARD and to promote freeze back.

The Tailings Storage Facility (TSF) is located with the Portage Pit Area and comprises the South Cell and the North Cell. These cells are delimited by tailings retaining dikes that are progressively built as capacity is required. The division of the TSF into cells allows tailings management in comparatively smaller areas with shorter beach lengths that reduce the amount of water that is trapped and permanently stored as ice. Operation in cells also allows progressive closure and covering.

Following the authorization of the in-pit amendment in 2019 the tailings deposition plan was reviewed to include tailings deposition in Goose Pit, Portage Pit A and Portage Pit E. This strategy allows storage

**WASTE ROCK AND TAILINGS MANAGEMENT PLAN**

of tailings within mined out pits to achieve the required capacity without requiring further raises of the North Cell and South Cell of the TSF.

Tailings are deposited sub-aerially and sub-aqueously as a slurry using the end of pipe technique. Tailings deposition is alternated between the North Cell, South Cell, and the approved in-pit deposition pits as per the annual tailings deposition plan. In 2023, tailings deposition occurred in Pit E and the South Cell.

Following mine operations, a cover of NPAG rockfill will be placed over the tailings in the North Cell and the South Cell of the TSF to ensure the protection of the runoff water quality over the facility. The final thickness of the rockfill cover layer will be confirmed in the final design based on modelling and monitoring of the site conditions to be completed during operations. Progressive capping is ongoing in the North Cell since 2015.

Thermal monitoring is ongoing to observe the freeze-back of the TSF and RSFs. Additional instruments will be installed at closure.

All infrastructures needed for mine operations, closure, and reclamation, including mine waste management areas, will be re-contoured and/or surface treated during closure, according to site specific conditions, to minimize windblown dust and erosion from surface runoff.

DOCUMENT CONTROL

Version	Date (YM)	Section	Page	Revision
1	2009/10	All	All	Original Plan
2	2013/04	All	All	Comprehensive update to Original Plan
3	2014/03	All	All	Comprehensive update to Original Plan
4	2015/03	Section 1, 2, 3, 4, 5, 6		Updated with the actual Life of Mine (LOM) for operations ending in Q3 2017
		Section 7		Updated according to the tailings deposition plan and water balance for the actual Life of Mine (LOM) for operations ending in Q3 2017
		Section 8		Updated according to additional instruments installed and future monitoring plan
		Section 9		Updated according to additional monitoring plan for final closure design
5	2016/03	All	All	Comprehensive update to Original Plan
6	2017/03	All	All	Comprehensive update to Original Plan
7	2018/03	All	All	Comprehensive update to Original Plan
8	2019/03	All	All	Comprehensive update to Original Plan.
9	2019/07			Interim update to 2018 plan to include in-pit disposal following authorization of amendment
10	2020/03	All	All	Comprehensive update to Original Plan.
11	2021/03	All	All	Comprehensive update to Original Plan.
12	2022/03	All	All	Comprehensive update to Original Plan.
13	2023/03	Section 3, 6, 8	All	Section 3 NPAG volumes, Section 6 tailings deposition volumes/parameters/plan, Section 8 monitoring of TSF/RSFs
14	2024/02	Section 2.3.1, 3, 6, 7, 8	All	TSF infrastructure, NPAG volumes, tailings management strategy and parameters, TSF cover design, Appendices



MEADOWBANK GOLD MINE
WASTE ROCK AND TAILINGS MANAGEMENT PLAN

Prepared By: Environment & Critical Infrastructure Department

Approved by: Eric Haley – Environment & Critical Infrastructure Superintendent

Table of Contents

1	INTRODUCTION	1
2	BACKGROUND INFORMATION.....	2
2.1	Site Conditions.....	2
2.1.1	Climate	2
2.1.2	Faults.....	3
2.1.3	Permafrost	5
2.2	Mining Operation Description	7
2.2.1	Portage Pit Area	7
2.2.2	Goose Pit Area	9
2.2.3	Vault Pit Area	10
2.3	Tailings Storage Facility Description	10
2.3.1	In-Pit Tailings Storage Description	11
3	MINE DEVELOPMENT PLAN	13
3.1	Mine Waste Production Sequence	13
4	OVERBURDEN MANAGEMENT	15
4.1	Lakebed Sediments.....	15
4.2	Till	15
5	WASTE ROCK MANAGEMENT.....	16
5.1	Waste Rock Management Strategy	16
5.2	Waste Rock Storage Facility Characteristics	16
6	TAILINGS MANAGEMENT	18
6.1	Tailings Management Strategy	18
6.1.1	TSF Tailings Management Strategy	18
6.1.2	In-Pit Tailings Management Strategy	19



WASTE ROCK AND TAILINGS MANAGEMENT PLAN

6.2	Tailings Deposition.....	20
6.2.1	Parameter Analysis	20
6.3	Tailings Deposition Plan.....	21
6.4	Monitoring of tailings seepage.....	22
6.5	Monitoring of Tailings Dust	22
7	CONTROL STRATEGIES FOR ACID ROCK DRAINAGE – COVER DESIGN.....	23
7.1	TSF Cover Design	25
7.2	In-Pit Cover Design	25
7.3	RSF Cover Design	26
8	MONITORING AND CLOSURE.....	27
8.1	TSF Reclamation	27
8.2	In-Pit Closure	28
8.2.1	Pore Water Quality	28
8.3	RSF Closure	28
9	REFERENCES	32

List of Tables

<i>Table 2-1: Estimated Average Monthly Climate Data – Meadowbank Site</i>	3
<i>Table 2-2: Summary of Reported Climate Change Rates Used in Northern Projects Engineering Studies</i>	5
<i>Table 2-3: TSF Infrastructure Description</i>	12
<i>Table 3-1: Summary of Mine Waste Tonnage and Destination</i>	14
<i>Table 3-2: Projected Use of NPAG/NML Waste Rock Tonnage for Closure and Reclamation</i>	14
<i>Table 5-2: Details of Rock Storage Facilities</i>	17
<i>Table 6-1: Deposition Location (Realized)</i>	20
<i>Table 6-2: Yearly Tailings Deposition Parameter Evolution – TSF</i>	21
<i>Table 6-3: Yearly Tailings Deposition Parameter Evolution – IPD</i>	21
<i>Table 6-4: Deposition Plan – Summary</i>	22
<i>Table 7-1: Acid Mine Drainage Control Strategies of the Arctic</i>	24

List of Figures

Figure 2-1: Meadowbank Mine Location.....	2
Figure 2-2: Portage Pit Area Fault Locations (light blue lines).....	4
Figure 2-3: Annual average temperature estimated for the RCP4.5, RCP6.0 and RCP8.5 climate change scenarios. Observed temperature at Baker Lake is also shown.....	7
Figure 2-4: Portage Pit and Tailings Storage Facility Infrastructures	8
Figure 2-5: Goose Pit Area Map.....	9
Figure 2-6: Vault Pit Area Map	10
Figure 5-1: Waste Rock Expansion Area (Temporary NAG Storage Area).....	17
Figure 8-1: Site Post Closure Concept.....	29
Figure 8-2: Portage Tailings and Rock Storage Closure Design Concept Cross Section	30
Figure 8-3: Vault Rock Storage Closure Design Concept Cross Section	31

Appendices

Appendix A: Meadowbank Mined Material Balance (2009-2023)

Appendix B: TSF and Pits Integrated Deposition Plan



1 INTRODUCTION

Agnico Eagle Mines Ltd. Meadowbank Division (AEM) is operating the Meadowbank Gold Mine (the Mine), located on Inuit-owned surface lands in the Kivalliq region approximately 70 km north of the Hamlet of Baker Lake, Nunavut. The Mine is subject to the terms and conditions of both the Project Certificate issued in accordance with the Nunavut Land Claims Agreement Article 12.5.12 on December 30, 2006, and the Nunavut Water Board Water License No. 2AM-MEA1530 amended on May 12, 2020.

The management, monitoring, and closure strategies for both the waste rock storage facility and tailings storage facility are presented in this document.

2 BACKGROUND INFORMATION

2.1 SITE CONDITIONS

The location of the Meadowbank mine site is shown in Figure 2.1.

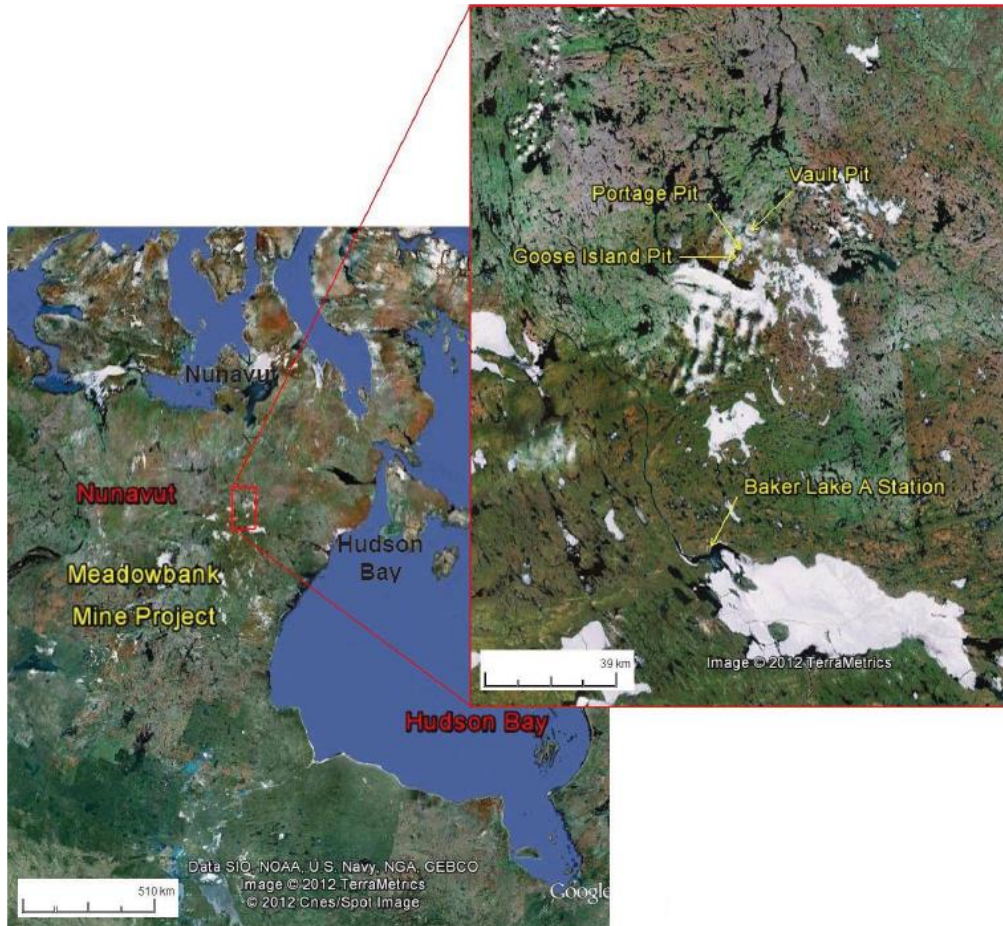

Source: Google Earth Pro, 2012

Figure 2-1: Meadowbank Mine Location

2.1.1 Climate

The Meadowbank region is located within a low Arctic Eco climate described as one of the coldest and driest regions of Canada. Arctic winter conditions occur from October through May, with temperatures ranging from +5°C to -40°C. Summer temperatures range from -5°C to +25°C with isolated rainfall increasing through September (Table 2-1).

Table 2-1: Estimated Average Monthly Climate Data – Meadowbank Site

Month	Max. Air Temp. (°C)	Min. Air Temp. (°C)	Rainfall (mm)	Snowfall (mm)	Total Precip. (mm)	Lake Evap. (mm)	Min. Relative Humidity (%)	Max. Relative Humidity (%)	Wind Speed (km/h)	Soil Temp. (°C)
January	-29.1	-35.5	0	11.2	11.2	0	67.1	75.9	16.3	-25.5
February	-27.8	-35.2	0	10.5	10.5	0	66.6	76.5	16.0	-28.1
March	-22.3	-30.5	0.1	14.6	14.6	0	68.4	81.4	16.9	-24.9
April	-13.3	-22.5	2.3	16.7	19.0	0	71.3	90.1	17.3	-18.1
May	-3.1	-9.9	9.8	11.3	21.1	0	75.7	97.2	18.9	-8.0
June	7.6	0.0	14.5	3.9	18.4	8.8	62.6	97.2	16.4	2.0
July	16.8	7.2	36.7	0.0	36.7	99.2	47.5	94.3	15.1	10.5
August	13.3	6.4	45.5	0.9	46.4	100.4	59.2	97.7	18.4	9.3
September	5.7	0.9	30.1	8.8	38.9	39.5	70.8	98.6	19.3	3.6
October	-5.0	-10.6	3.5	30.3	33.8	0.1	83.1	97.4	21.4	-2.8
November	-14.8	-22.0	0	23.6	23.6	0	80.6	91.1	17.9	-11.7
December	-23.3	-29.9	0	15.0	15.0	0	73.3	82.7	17.7	-19.9

Note: Data from Baker Lake A station is available from 1946 to 2011. During this period, the data quality is good, with the exception of years 1946 to 1949, and 1993 which were removed from the compilation.

The long-term mean annual air temperature for Meadowbank is estimated to be approximately - 11.1°C. Air temperatures at the Meadowbank area are, on average, about 0.6°C cooler than Baker Lake air temperatures, and extreme temperatures tend to be larger in magnitude. This climatic difference is thought to be the effect of a moderating maritime influence at Baker Lake.

The prevailing winds at Meadowbank for both the winter and summer months are from the northwest. A maximum daily wind gust of 115 km/h was recorded on November 21, 2023. Light to moderate snowfall is accompanied by variable winds up to 70 km/h, creating large, deep drifts and occasional whiteout conditions. Skies tend to be more overcast in winter than in summer.

Table 2-1 presents monthly rainfall, snowfall, and total precipitation values for the mine site. August is the wettest month, with a total precipitation of 43.4 mm, and February is the driest month, with a total precipitation of 6.1 mm. During an average year the total precipitation is 249.6 mm, split between 147.5 mm of rainfall and 102.1 mm of snowfall precipitation.

2.1.2 Faults

Two main faults are inferred in the Portage deposit area and included in the groundwater model (Golder, 2011) used to estimate groundwater inflows and brackish water upwelling to the pits during mine life. These are the Bay Zone Fault and the Second Portage Fault shown in Figure 2.2 by bright blue lines.

WASTE ROCK AND TAILINGS MANAGEMENT PLAN

The Second Portage Fault trends to the northwest under Central Dike and the Tailings Storage Facilities (TSF), roughly parallel to the orientation of Second Portage Lake. This fault has been identified as a potential pathway for the Central Dike Seepage.

The Bay Zone Fault trends from South to North and crosses Third Portage Lake, Goose Pit and Portage Pit. This fault is a potential pathway for water infiltration from Third Portage Lake into Goose Pit.

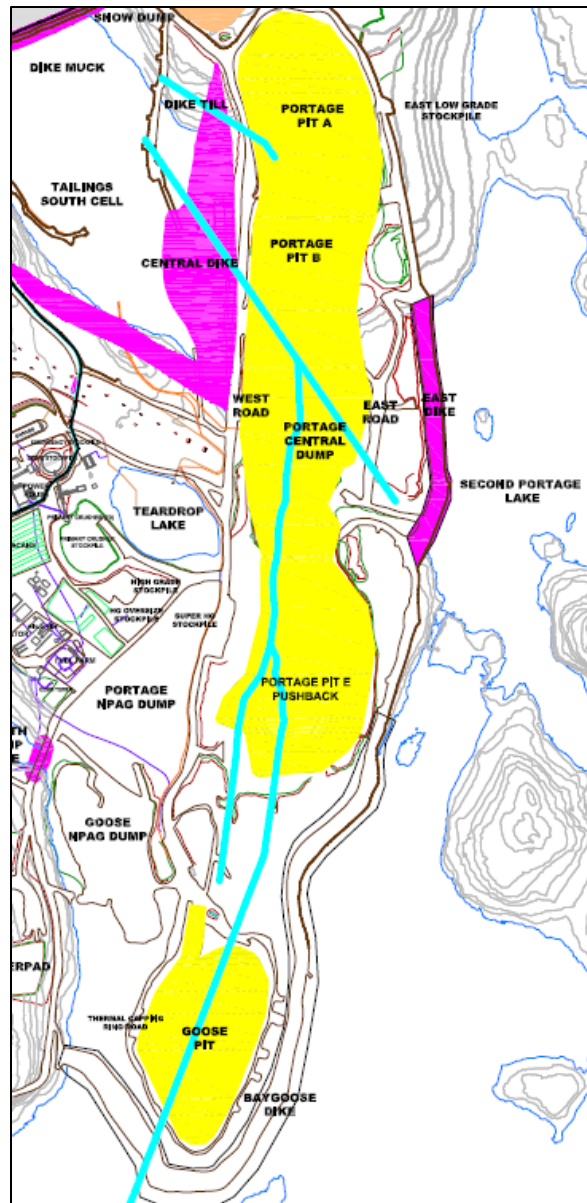

Figure 2-2: Portage Pit Area Fault Locations (light blue lines)

2.1.3 Permafrost

The Meadowbank Gold Mine is located in an area of continuous permafrost. Lake ice thicknesses between 1.5 m and 2.5 m have been encountered in mid to late spring during geotechnical investigations and sampling campaigns. Taliks (areas of permanently unfrozen ground) are expected where water depth is greater than about 2 to 2.5 m. Based on thermal studies and measurements of ground temperatures (Golder, 2003), the depth of permafrost at site is estimated to be in the order of 450 to 550 m, depending on proximity to lakes. The depth of the active layer is about 1 to 1.5 m and varies based on stratigraphy, presence of overburden and vegetation, and proximity to lakes.

Based on ground conductivity surveys and compilation of regional data, the ground ice content is expected to be low. Locally on land, ice lenses and ice wedges are present, as indicated by ground conductivity, and by permafrost features such as frost mounds. These areas of local ground ice are generally associated with low-lying areas of poor drainage.

2.1.3.1 Impact of Climate Change on Site Conditions

Table 2-2 presents a summary of climate change predictions used on a number of northern projects that have been reported in the engineering and scientific literature. Further studies incorporating climate change references will be done using the climate change predictions from the IPCC (Intergovernmental Panel on Climate Change) RCPs (Representative Concentration Pathways) RCP6.

Table 2-2: Summary of Reported Climate Change Rates Used in Northern Projects Engineering Studies

Reference	Increase in Mean Annual Air Temperature (MAAT) by Year 2100 (°C)	Notes
Hayley (2004)	4.7	Used in design studies for the Inuvik Regional Health Center. Reported as increase of 0.47°C per decade.
Hayley and Cathro (1996)	5.0	Used for Raglan Dam analyses.
Diavik	3.2	Used for the Processed Kimberlite Containment Facility Design
Burn (2003)	6.0	For use in the Western Arctic for pipeline design projects. Reported as increase of 1.75°C over a 29 year period
Intergovernmental Panel on Climate Change (AR5)	See Figure 2.3	RCP 6.0 to be used as base case

As part of the Intergovernmental Panel on Climate Change’s (IPCC) Fifth Assessment Report (AR5), the IPCC adopted new Representative Concentration Pathways (RCPs) to replace the previous emission scenarios of the Special Report on Emission Scenarios (SRES) (IPCC 2013). The four adopted RCPs differ from the SRES in that they represent greenhouse gas concentration trajectories, not emissions trajectories. The four scenarios (RCP2.6, RCP4.5, RCP6.0 and RCP8.5) are named after the radiative

target forcing level for 2100, which are based on the forcing of greenhouse gases and other agents and are relative to pre-industrial levels.

The climate change database for Meadowbank and Whale Tail Mine was developed following the recommendations outlined on the Canadian Climate Data and Scenarios (CCDS) website, which is wholly supported by ECCC (CCDS, 2018). The website recommends the use of statistical downscaling to “downscale” a GCM’s (General Circulation Model) predictions to a specific location based on historical observations. Statistical downscaling is a two-step process consisting of i) development of statistical relationships between local climate variables (e.g., surface air temperature and precipitation) and large-scale predictors (e.g., pressure fields), and ii) application of such relationships to the output of GCM experiments to simulate local climate characteristics in the future. The Pacific Climate Impact Consortium (PCIC) at the University of Victoria provides statistically downscaled daily temperature and precipitation under the RCP2.6, RCP4.5 and RCP8.5 scenarios for all of Canada at a resolution of approximately 10 km (PCIC, 2018). The second-generation Canadian Earth System Model (CanESM2), developed by the Canadian Centre for Climate Modelling and Analysis (CCCma), was used as the predictor GCM to downscale, and make climate change databases representative of site conditions.

Statistical downscaling is limited by the availability of large-scale predictors. Current CCCma CanESM2 model runs are limited temporally to 2100. To predict beyond 2100, the radiative forcing trend was applied to the temperature. RCP4.5 and RCP6.0 are expected to stabilize shortly after 2100, while RCP8.5 is expected to continue along the same trend until after 2200.

Temperatures are anticipated to rise at about the same rate (approximately 0.06°C/year) for RCP4.5 and RCP6.0 until approximately 2070, after which RCP4.5 estimates a reduction in the temperature increase rate. Under RCP8.5, temperatures are expected to increase at a higher rate (approximately 0.12°C/year) for the duration of the modelled period. All three scenarios predict an increase in precipitation with time of approximately 0.5 mm/year (75 mm total increase over 150 years) for RCP4.5, 0.6 mm/year (90 mm total increase over 150 years) for RCP6.0 and 0.7 mm/year (100 mm total increase over 150 years) for RCP8.5.

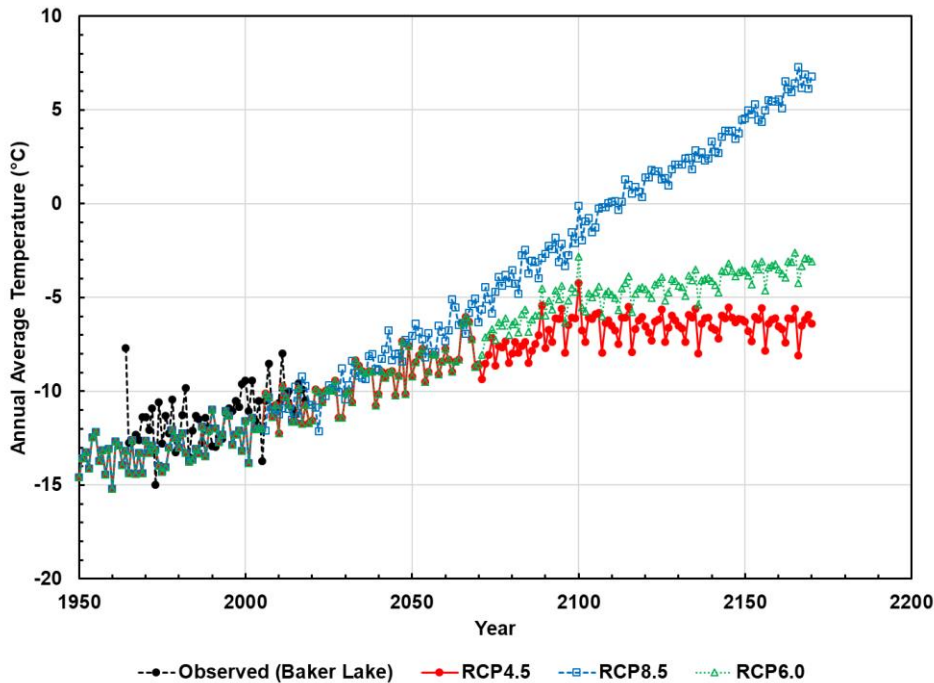

Figure 2-3: Annual average temperature estimated for the RCP4.5, RCP6.0 and RCP8.5 climate change scenarios. Observed temperature at Baker Lake is also shown.

2.2 MINING OPERATION DESCRIPTION

Mining in the Meadowbank area pits concluded in October 2019. Mining is ongoing at the Whale Tail Mine and the ore is transported to the Meadowbank mill for processing.

The Meadowbank Gold Mine consists of several gold-bearing deposits within reasonable proximity to one another. The three main deposits are: Vault (including Phaser and BB-Phaser), Portage (South, Center and North Portage deposits), and Goose.

2.2.1 Portage Pit Area

The Portage area located between the Third Portage Lake (3PL) and Second Portage Lake (2PL) contains most of the infrastructure of the Meadowbank mine site including but not limited to the Portage RSF, North Cell and South Cell Tailings Storage Facilities (NC & SC TSF), the mill, the camp, and the Stormwater Management Pond.

The South Portage deposit is located on a peninsula and extends northward under 2PL and southward under 3PL. The North Portage deposit is located on the northern shore of 2PL. The South, Center and North Portage deposits are mined as a single pit, termed the Portage Pit, which extends approximately 2 km in a north-south direction. Subsequent renaming of the pits led to the nomenclature for each pit

(A, B, C, D and E.) Portage Pit is isolated from the Second Portage Lake by the East Dike built in 2008-2009 and the Bay-Goose Dike (Pit E) built from 2009 to 2011.

Mining in the Portage Pit area concluded in 2019. Since then, there is no more mining activity at Meadowbank.

Figure 2-4 shows the Portage Pit Area and surrounding infrastructures.

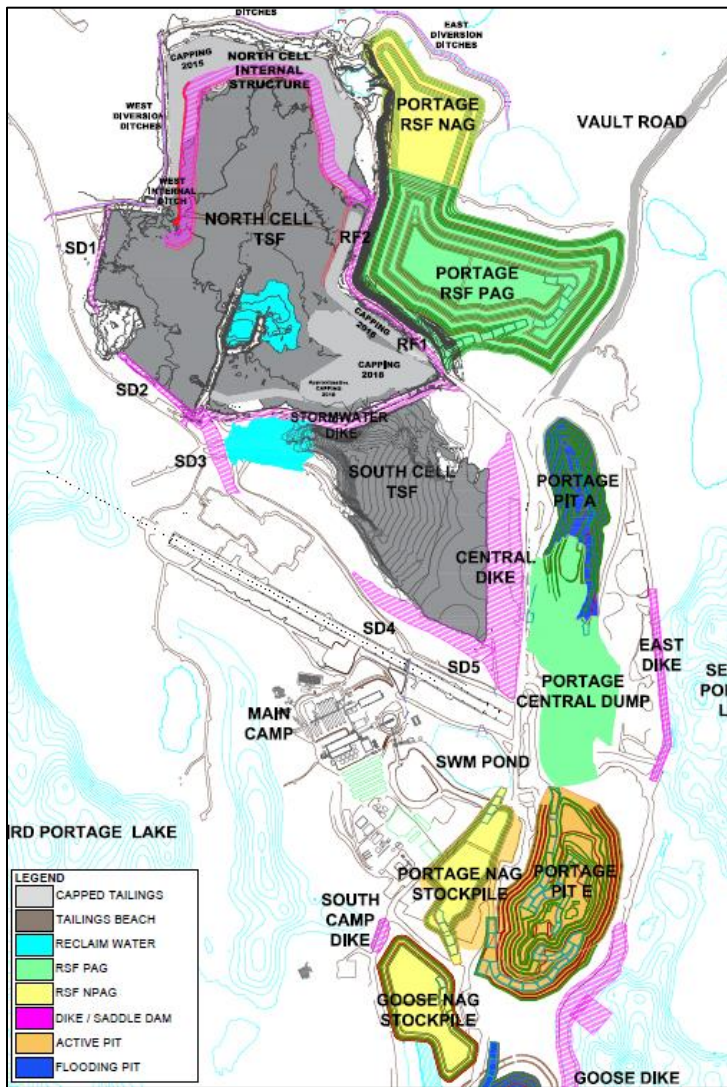

Figure 2-4: Portage Pit and Tailings Storage Facility Infrastructures

2.2.2 Goose Pit Area

The Goose deposit lies approximately 1 km to the south of the Portage deposit, and beneath 3PL. The pit is isolated from the Second Portage Lake and the Third Portage Lake by the Bay-Goose Dike and the South Camp Dike constructed in 2009-2010. Mining in Goose Pit began in 2012 and was completed in April 2015. The northern part of the pit was historically used for pit infilling. The Goose Pit area and surrounding infrastructure are illustrated in Figure 2-5.

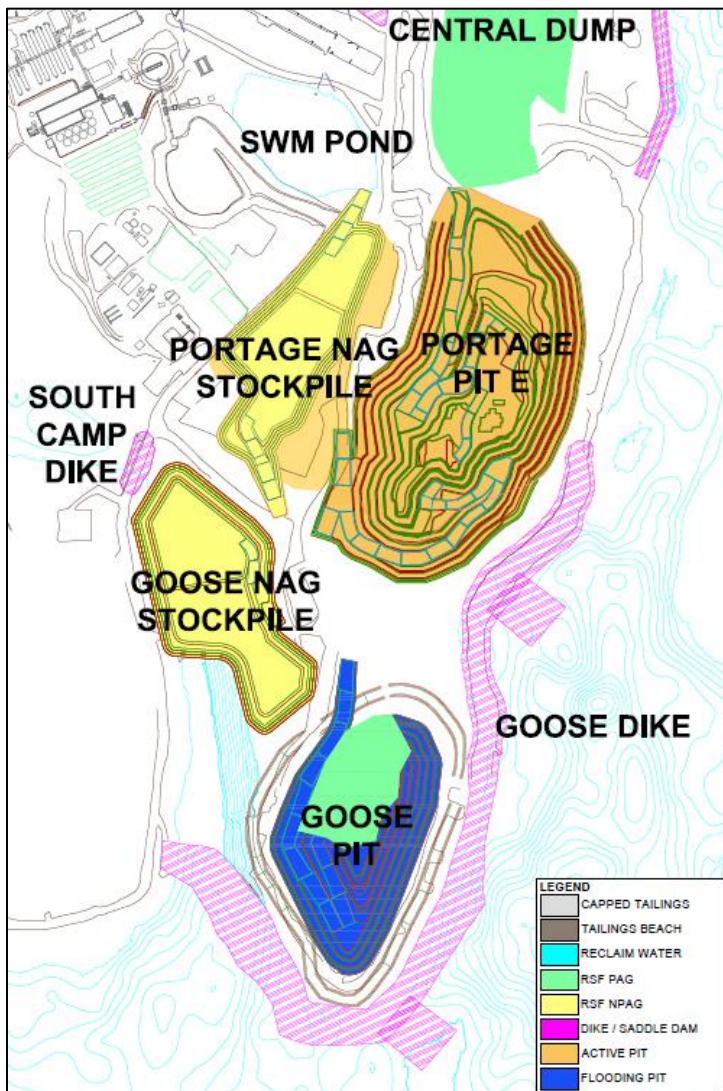

Figure 2-5: Goose Pit Area Map

2.2.3 Vault Pit Area

The infrastructure of the Vault Pit area includes the Vault RSF, ore and marginal pads, Vault Dike, Vault Pit, Phaser Pit, BB-Phaser Pit, Vault attenuation pond, and emergency shelter. Figure 2-6 illustrates the Vault Pit area and surrounding infrastructure.

The Vault deposit is located adjacent to Vault Lake, approximately 6 km north of the Portage deposits. The deposit is isolated from the Wally Lake by the Vault Dike built in 2013.

The Vault Pit area mining activity was completed in 2019 with the conclusion of Vault Pit in March 2019 and BB-Phaser Pit in June 2019. Phaser Pit mining activities were completed in October 2018.

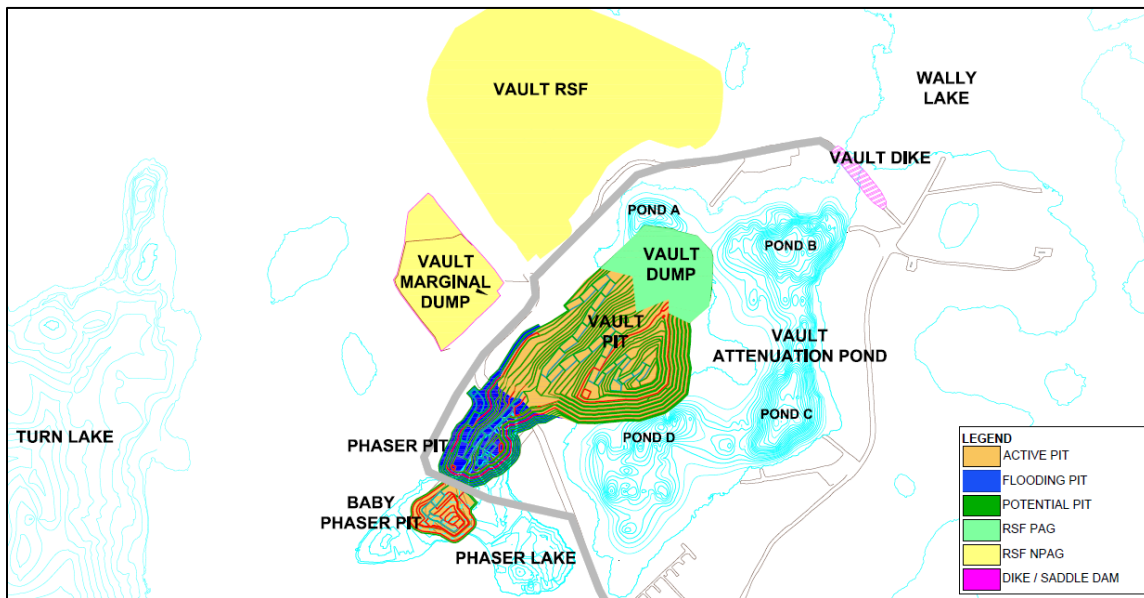

Figure 2-6: Vault Pit Area Map

2.3 TAILINGS STORAGE FACILITY DESCRIPTION

The Tailings Storage Facility (TSF) is located with the Portage Pit Area and is comprised of the South Cell and the North Cell. These cells are delimited by tailings retaining dikes that were progressively built as capacity was required. The configuration of the TSF is presented on Figure 2-4. A summary of the TSF infrastructure is presented in Table 2-3.

Stormwater Dike, constructed in 2009-2010, is an internal dike (El. 150m) that divides the TSF into the North and South Cell.

The peripheral structures of the North Cell are SD1, SD2, RF1 and RF2 built to El 150 m from 2009 to 2010. In 2018, an internal structure was built in the Northern part of the North Cell over the existing tailings (variable El. From 152 to 154 m) to increase the tailings storage capacity. In April 2019, a permeable berm was built in the North Cell to secure the reclaim pond from tailings entering.

The peripheral structures of the South Cell are SD3, SD4, SD5 and Central Dike built to El. 145 m from 2012 to 2018.

A permeable berm was built in the South Cell in 2017, to prevent tailings from reaching the reclaim pump area. In February 2019 an additional permeable berm was built within the South Cell TSF to maintain reclaim capability. In July 2023 the berm was remediated to accommodate additional tailings deposition.

The diversion ditches (East and West), located around the perimeter of the North Cell TSF and the Portage RSF, are designed to collect the non-contact water runoff from the surrounding watershed.

2.3.1 In-Pit Tailings Storage Description

In-Pit tailings storage is occurring in the mined-out areas of Goose Pit, Portage Pit A and Portage Pit E.

WASTE ROCK AND TAILINGS MANAGEMENT PLAN

Table 2-3: TSF Infrastructure Description

Containment Area	Structure	Construction date	Purpose
North Cell (NC)	Saddle Dam 1	Built to el. 141m - 2009 Raised to el. 150m - 2010	Peripheral Dike Tailings Retention
	Saddle Dam 2	Built to el. 150m - 2011	Peripheral Dike Tailings Retention
	Rockfill road structure 1 (RF1)	Built to el. 150m – 2009 Till Plug Constructed in 2013	Access Road Tailings Retention
	Rockfill road structure 2 (RF2)	Built to el. 150m - 2009	Access Road Tailings Retention
	Stormwater Dike	Built to el. 140m - 2009 Raised to el. 148m – 2010 Raised to el. 150m - 2013	Divider Dike Tailings Retention
	North Cell Internal Structure (NCIS)	Built to el. variable 152-154m - 2018 West extension built to el. 150.5 - 2023	Internal Structure Tailings Retention
	North Cell Capping	2015 to 2019	Progressive closure
	Permeable Berm	Built to el.148.5m – 2019 Raised to el. 149.5 – 2023	Water management
South Cell (SC)	Saddle Dam 3	Built to el. 140m - 2015 Raised to el. 143m - 2016 Raised to el. 145m – 2017-2018	Peripheral Dike Tailings Retention
	Saddle Dam 4	Built to el. 140m - 2015 Raised to el. 143m - 2016 Raised to el. 145m - 2017	Peripheral Dike Tailings Retention
	Saddle Dam 5	Built to el. 143m - 2016 Raised to el. 145m - 2017	Peripheral Dike Tailings Retention
	Central Dike	Built to el. 110m - 2012 Raised to el. 115m - 2013 Raised to el. 132m - 2014 Raised to el. 143m - 2016 Raised to el. 145m - 2017-2018	Peripheral Dike Tailings Retention
	Permeable Berm 1	Built to el. 137.25 - 2017	Water management
	Permeable Berm 2	Built to el. 141.5 – 2019 Raised to el. 142.0 – 2023	Water management
In-pit deposition (IPD)	Goose Pit	Commissioned in July 2019	Tailings Retention
	Pit E	Commissioned in July 2019	Tailings Retention
	Pit A	Commissioned in July 2019	Water management and later Tailings Retention

3 MINE DEVELOPMENT PLAN

3.1 MINE WASTE PRODUCTION SEQUENCE

The current mine plan has no Meadowbank mining planned since mining operations at Meadowbank (Portage, Goose, Vault, Phaser and BB-Phaser pits) completed.

The material balances from 2009 to 2023 is presented in Appendix A. This balance indicates the distribution of the categories of materials mined and their destination. Table M in Appendix A compares the amount of waste mined to the Final Environmental Impact Statement (FEIS) prediction. It is to be noted that the difference in PAG and NPAG mined compared to the FEIS does not impact the management strategy and the closure concept. Please note that since mining operations at Meadowbank are completed no material will be produced other than tailings.

The proposed usage or destination of the mine waste materials is presented in Table 3.1. Table 3.2 indicates the main areas that will require NPAG/NML waste rock for closure and reclamation, with estimated quantities.

Based on current material balance calculations, enough suitable rock fill material will be available for capping activities and closure/reclamation projects, based on current designs. The NPAG material for closure activity is planned to be sourced from the Goose and Portage NPAG stockpiles.

WASTE ROCK AND TAILINGS MANAGEMENT PLAN

Table 3-1: Summary of Mine Waste Tonnage and Destination

Mine Waste Stream	Estimated Quantities	Waste Destination
Total Mined Waste Material	235.7 Mt	Portage and Vault WRSF
		Construction material
		Pit Backfill material
Total Overburden	12.5 Mt	Construction material
		Co-disposed with waste rock in WRSF
Total PAG	115.2 Mt	Vault and Phaser Pit Backfill Material (95% NPAG, 5% PAG), Portage Pit Backfill Material (100% PAG)
		Portage WRSF (19% NPAG, 81% PAG) and Vault WRSF (95% NPAG, 5% PAG)
Total NPAG	108.0 Mt	Vault and Phaser Pit Backfill Material (95% NPAG, 5% PAG)
		Vault WRSF (95% NPAG, 5% PAG)
		Construction material (100% NPAG)
		Portage WRSF Cover (100% NPAG)
		All Goose and Portage NPAG stockpiles (Available for closure and site reclamation, 100% NPAG) 26.5 Mt

Table 3-2: Projected Use of NPAG/NML Waste Rock Tonnage for Closure and Reclamation

Area	Activity	Volume Required of NPAG /NML waste (tonnes)
Portage WRSF	Completion of cover landform	1,042,170
SC / NC	Completion of tailings landform	18,466,000
Pit	Placement of cover over pit tailings (if required based on feasibility evaluation)	2,146,000
Finger Dikes / Stream Spawning Pads	Fish habitat compensation construction	81,524
Portage WRSF	Portage WRSF toe landfill NPAG berm and top capping construction	343,946
Total		22,079,640

4 OVERBURDEN MANAGEMENT

4.1 LAKEBED SEDIMENTS

The lakebed sediment consists of soft, fine-grained sedimentary deposits that can be found at the bottom of lakes.

The thickness of lake bottom sediments at Meadowbank is variable and can range from a few centimeters up to 10 meters and more as suggested by geophysical surveys and information obtained from various drilling programs and construction activities.

Lakebed sediments were excavated and managed during the construction of Stormwater Dike, Central Dike and of the dewatering dikes as well as during pre-stripping of the Pits.

The strategy to manage lakebed sediment removed during construction or pre-stripping was to place it in either the Portage or Vault RSF.

4.2 TILL

The remainder of the overburden materials consists of till materials (mix of silt, sand, gravel, cobbles, and boulders) with alluvial deposits of silt and sand intermixed. The till material is generally described as a silty sand/gravel. It contains cobble and boulder-sized particles with an average of 30 to 40% silt particles. The average till thicknesses throughout the Mine area varies based on location and may range from zero to upwards of 18 m.

The management strategy for till was to stockpile a part of it to be used for construction of the tailings management infrastructure as required. The remaining quantity of till was co-disposed with waste rock within the RSFs.

5 WASTE ROCK MANAGEMENT

Waste rock from the open pit mines, not used for site development purposes, is stored within the Waste Rock Storage Facilities (RSFs). Due to the distance between the Portage mining area and the Vault mining area, two separate waste rock storage facilities were required. Waste rock from the Portage and Goose Pits are stored in a storage facility located near these pits (Portage RSF or Goose Pit dump), while waste rock from the Vault, Phaser and BB-Phaser Pits is stored in a separate storage facility adjacent to the Vault Pit (Vault RSF). Waste rock is also stored within mined out areas of pits (pit-infilling).

5.1 WASTE ROCK MANAGEMENT STRATEGY

Waste rock is managed within the RSFs as well as within the mined-out areas of Portage, Goose, Vault, and Phaser Pits. The waste rock is classified with testing as non-potentially acid generating (NPAG) or potentially acid generating (PAG). The management strategy for NPAG and PAG material is different.

Placement of waste rock within the Portage RSF commenced closest to the Portage Pit and progressed westward over the entire footprint, then upward to further benches during the development of the mine. In 2012, an extension of the Portage WRSF was done to store NPAG material within a temporary area (Figure 5-1).

Placement of waste rock within the Vault RSF commenced closest to the Vault Pit and proceeded in a northward direction, rising upward as pit development progressed.

PAG rockfill is managed within the Portage RSF, Vault RSF, Portage Pit infill, and Vault and Phaser Pit infill. The PAG rockfill within the Portage RSF is placed inside of the capping area (which consists of a thickness of 4 m at surface). At the Vault RSF the majority of the rockfill is NPAG with the PAG placed within the middle area.

NPAG rockfill is managed as construction material, capping material for the TSF, Goose Pit infill, Vault infill, Phaser infill, and within the Portage and Vault RSF. At the Portage RSF the NPAG is stored within a temporary NPAG stockpile area and is also used as capping for the PAG material. In the Vault RSF, NPAG material consists of the majority of the RSF.

5.2 WASTE ROCK STORAGE FACILITY CHARACTERISTICS

Table 5-1 summarizes the overall (final) physical dimensions and aspects of the Portage and Vault RSFs.

Table 5-1: Details of Rock Storage Facilities

Parameter	Portage Rock Storage Facility	Vault Rock Storage Facility
Storage volume	39.3 Mm ³	29.1 Mm ³
Final crest elevation	254 m	246 m
Final height	100 m	80 m
Maximum elevation of adjacent topography	192 m	190 m
Footprint area	80.8 ha	61.0 ha

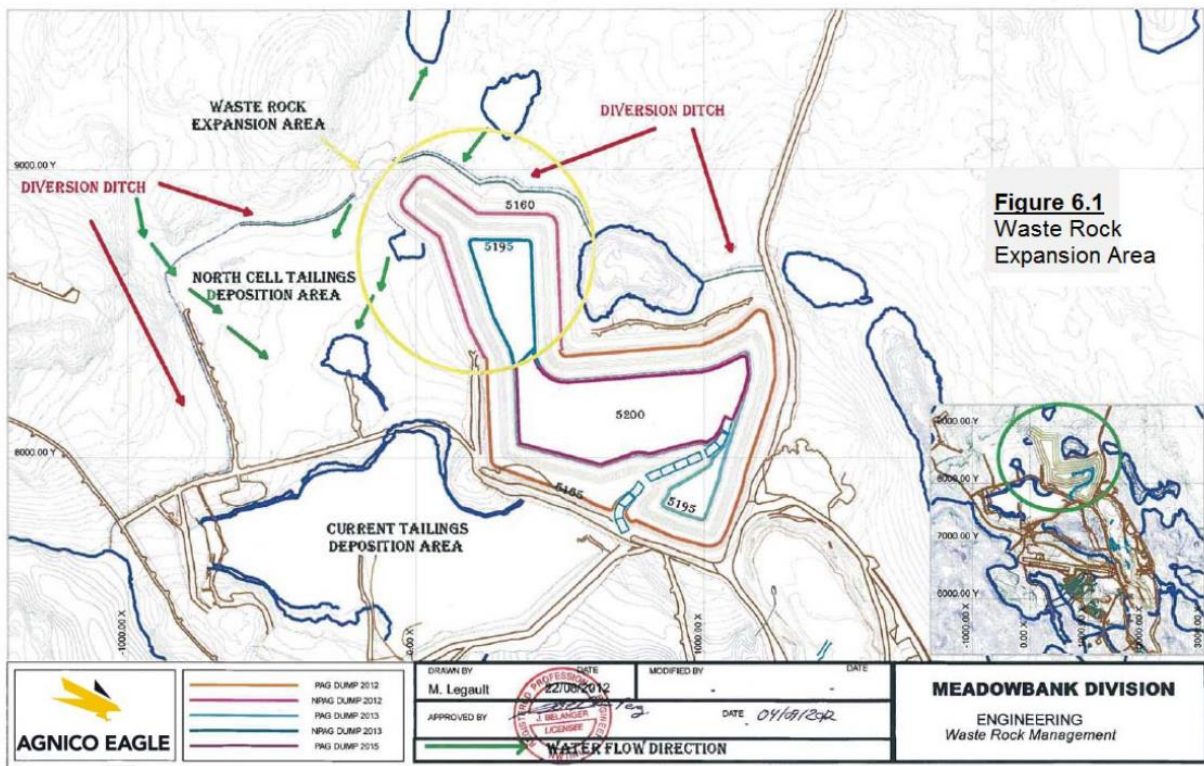

Figure 5-1: Waste Rock Expansion Area (Temporary NPAG Storage Area)

6 TAILINGS MANAGEMENT

Tailings are the material by-product of the gold recovery process produced by the process plant. Tailings are pumped as a slurry from the process plant to the TSF or to the mined-out area of Goose and Portage Pits.

The TSF is a permanent storage facility for tailings produced during the operation of the mine. It is located north of the Process Plant Site within the dewatered portion of the northwestern arm of 2PL.

Tailings containment in the TSF is achieved by the construction of a series of dikes. The structures of the TSF are raised as additional tailings capacity is required. The maximum allowed elevation of the North Cell and South Cell peripheral structures is El. 150 masl, while the maximum allowed elevation of the North Cell Internal Structure (NCIS) is El. 154 m. Refer to Section 2.3 for a description of the tailings containment infrastructures and their current elevation.

Tailings containment through in-pit deposition is achieved by depositing tailings in the mined-out areas of Goose Pit and Portage Pit.

6.1 TAILINGS MANAGEMENT STRATEGY

Tailings deposition is done using end of pipe deposition with one active point at a time. The deposition point location and duration are determined from the tailings deposition plan. Changing between deposition points on a given line consist of stopping the flow of tailings in the line, redirecting it through a by-pass, flushing the line, relocating the deposition point pipe, and then switching tailings from the by-pass to the newly installed deposition line.

6.1.1 TSF Tailings Management Strategy

The TSF was designed in two cells (North and South) to allow tailings management in smaller areas with shorter beach lengths, reducing the amount of water that is trapped and permanently stored as ice, which would result in losing TSF capacity. Operation in cells also allows progressive closure, cover trials, and cover construction.

Due to the arid climate and permafrost environment, tailings in the TSF are disposed in a manner promoting freeze-back. Given the duration that water at site is ice covered, sub-aqueous disposal is preferred. It is anticipated that the tailings will eventually become encapsulated by permafrost; thus, limiting oxygen diffusion and water infiltration into the tailings, seepage from the tailings, and the generation of Acid Mine Drainage (AMD). Refer to the water management plan for information on how water is managed within the TSF.

When discharging tailings in the TSF, planning is aligned with the tailings management strategy and considers the following aspects:

- The deposition sequence informs dike and internal structure construction activities and ensures enough capacity to store the life of mine tailings while maintaining adequate freeboard (2.0m for water and 0.5m for tailings).
- The deposition sequence maintains a reclaim pond with sufficient depth for efficient operation of the reclaim pumping system while minimizing pond volume as TSF operation best practices.
- The deposition sequence maintains beaches on the upstream faces of perimeter dikes.
- The deposition sequence promotes sub-aqueous deposition in winter to limit ice entrapment.
- The deposition sequence promotes freezing of the tailings during the operating period.
- The deposition sequence maximizes certain areas of the TSF earlier to promote rockfill capping during operation.

6.1.2 In-Pit Tailings Management Strategy

In-pit tailings disposal will occur in Goose Pit, Pit E, and Pit A. In-pit tailings deposition occurred in Goose Pit from July 2019 to August 2020. In-pit tailings deposition has since been within Pit E, with intermittent deposition in the NC and SC in 2021 and 2023.

In-pit tailings disposal was originally planned to occur using crest and ramp deposition points, with the long-term strategy to use crest deposition in summer, and discharge along the pit ramp in winter to facilitate water transfers. Since 2020, all deposition occurred from the crest and summer and winter discharge are the same due to operational constraints and safety concerns.

The in-pit tailings deposition strategy will respect these freeboard criteria:

- A minimum of 8 m tailings freeboard with 3PL water elevation (maximum tailings El. 125.6 masl). This freeboard is required to ensure a minimum water cover of 8 m at closure.
- Portage Pit A and Pit E water elevation to maintain a freeboard with the lowest point of the West Road if deemed required by geotechnical assessment results.
- Goose Pit tailings freeboard to respect a highest elevation of 120 masl, to ensure a 13.6m freeboard near Bay Goose Dike.

During in-pit tailings deposition, reclaim water is pumped to the mill from either Portage Pit A or Pit E. Reclaim water is pumped from a location that allows low levels of Total Suspended Solids (TSS) to be returned to the mill.

In addition, to ensure that the water level in Goose Pit remains below 128 masl during operation and to provide enough volume for the reclaim system, water from Goose Pit is transferred to Portage Pit A or Pit E as required. Water is also transferred in between Pit E, Pit A, and Goose Pit as required to maximize the reclaim performance and decrease the risks related to winter reclaim

operation. Water transfer from Goose Pit only occurs during the summer period. Switches of in-pit deposition point are scheduled as needed during planned extended mill shutdowns, generally in March or September.

6.2 TAILINGS DEPOSITION

Table 6-1 presents the history of tailings deposition in the TSF and the pits. Deposition was done according to the deposition plan, which considers various factors such as construction sequence, remaining capacity, and limiting ice entrapment during winter deposition.

Table 6-1: Realized Deposition

Period	Location	Tailings deposited (dry mass)
February 2010 to November 2014	North Cell	16.0 Mt
November 2014 to July 2015	South Cell	2.7 Mt
July 2015 to October 2015	North Cell	1.0 Mt
October 2015 to August 2018	South Cell	10.8 Mt
August 2018 to October 2018	North Cell	0.5 Mt
October 2018 to April 2019	South Cell	1.4 Mt
April 2019 to July 2019	North Cell	0.6 Mt
July 2019 to December 2019	Goose Pit	1.4 Mt
January 2020 to August 2020	Goose Pit	1.4 Mt
August 2020 to July 2021	Pit E	3.1 Mt
July 2021 to August 2021	North Cell	0.4 Mt
August 2021 to December 2022	Pit E	5.0 Mt
January to August 2023	Pit E	2.5 Mt
August 2023 to September 2023	South Cell	0.3 Mt
September 2023 to December 2023	Pit E	0.8 Mt

6.2.1 Parameter Analysis

Bathymetric survey is conducted every year in areas where tailings deposition occurred since the last bathymetry. Parameter analysis is performed using this data as required to fine tune the deposition model. Results of historical parameter analysis of the TSF and IPD are presented in Table 6-2 and Table 6-3.

Table 6-2: Yearly Tailings Deposition Parameter Evolution – TSF

		Tailings Dry Density (t/m ³)	Sub-Aerial beaches (%)	Sub-Aqueous beaches (%)	Ice entrapment (%)
2014	NC & SC	1.28	0.45	4.00	60%
2015	SC	1.45	1.10	3.60	36%
2016	SC	1.48	0.88	3.03	39%
2017	SC	1.30	0.73	2.95	38%
2018	SC	1.26	0.58	2.36	61%
2018	NC	1.28	0.45	2.36	61%
2023	SC	1.69	0.36	N.A.	N.A.

Note: Yearly averages are presented

Table 6-3: Yearly Tailings Deposition Parameter Evolution – IPD

		Tailings Dry Density (t/m ³)	Sub-Aqueous Beaches – First 100m (%)	Sub-Aqueous Beaches – Post 100m (%)
2019	Goose Pit	1.45	10.0	1.00
2020	Goose Pit	1.8	10.0	1.00
2021	Pit E	1.50	4.7	10.36
2022	Pit E	1.54	4.75	7.86
2023	Pit E	1.59	0.63	6.52

Note: Yearly averages are presented

6.3 TAILINGS DEPOSITION PLAN

An updated version of the tailings deposition plan until the end of milling is presented in Appendix B. This plan considers up to date tailings parameters. The water management strategy related to this deposition plan is also presented in Appendix B.

As mill processing profile and tailings characteristics may fluctuate over the life of the mine, the tailings deposition plan will continue to evolve based on changes in design parameters. Those include the mill process rates, tailings beach slopes, waste rock porosity, tailings specific gravity, and tailings in-situ densities. These parameters are re-evaluated every time the deposition plan is updated. Appendix B presents the input parameters that were used to update the tailings deposition plan.

Table 6-4 presents a summary of the deposition strategy from 2023 to 2026 based on the output of the deposition modelling. The strategy of this tailings deposition plan was to minimize freshwater consumption and ensure operational flexibility to react to potential new challenges brought by the in-pit deposition.

Table 6-4: Deposition Plan – Summary

Period	Location	Tailings deposited (dry mass)
January 2024 to July 2024	Pit E	3.9 Mt
August 2024	NC	0.35 Mt
September 2024 to July 2025	Pit E	3.8 Mt
August 2025	SC	0.36 Mt
September 2025 to June 2026	Pit E	2.1 Mt

6.4 MONITORING OF TAILINGS SEEPAGE

Following dewatering of the 2PL arm and during investigations and construction of the TSF perimeter dikes, several investigative procedures were used to identify the location and hydraulic properties of faults that are inferred to be present beneath the North Arm of 2PL including mapping of exposed bedrock and packer testing in boreholes.

The results of the investigations were used to locate monitoring wells and thermistors that are installed within the dikes, and between the Central Dike and crest of the Portage Pit. Thermal data is monitored to evaluate seepage and freeze-back of the TSF, and of the Central Dike, Saddle Dams and Rockfill perimeter containment foundations. More information regarding thermal data and monitoring is in the Thermal Monitoring Plan and the Thermal Monitoring Report.

- If monitoring indicates flow rates and water qualities of concern, then mitigation measures would be undertaken. Collection of any seep water will be required for pumping it back to the TSF. The potential mitigation action would be dependent on observed flow rates and water quality data.
- If, during monitoring, the freeze-back of the dike and tailings deposit is found to be occurring at a rate inferior than that predicted, mitigation methods may be considered.

Refer to the Water Management Plan and Annual Report for details on the Central Dike seepage and to the Tailings Storage Facilities OMS Manual for seepage monitoring and mitigation actions.

6.5 MONITORING OF TAILINGS DUST

Since tailings deposition has been switched from the South Cell and North Cell to the pits, the tailings surface has been progressively drying out, especially in the North Cell where less water is retained. As a result, the surface is more prone to erosion by the wind in the absence of continuous deposition. In October 2020, high winds combined with the dry tailings surface generated a significant dust event. A communication was sent to the DFO and mitigation measures were successfully implemented in 2021 and 2022 to prevent further dust generation from wind erosion. In 2023, fresh tailings were deposited in SC for an increased mitigation of dust generation.

7 CONTROL STRATEGIES FOR ACID ROCK DRAINAGE – COVER DESIGN

Some rock lithologies from the Meadowbank mining activity are potentially acid generating (PAG) which can raise the concern of generating acid drainage. This section describes the control strategy for the concept to limit acid rock drainage from the tailings and waste rock at Meadowbank as presented in the approved Interim Closure and Reclamation Plan (ICRP). The 2019 Meadowbank ICRP (March 2020) is available in Appendix 55 of the 2019 Meadowbank Annual Report.

During selection of the acid rock drainage control strategies for the disposal of the mine waste at the Meadowbank Gold Mine, consideration was given to control strategies that are effective in Arctic regions.

Common control strategies for the prevention or reduction of AMD in cold regions are:

1. Control of acid generating reactions.
2. Control of migration of contaminants.
3. Collection and treatment.

In assessing the overall control strategies for the Meadowbank Gold Mine, emphasis has been placed on methods that satisfy (1) and (2), which then has an impact on (3) by potentially reducing the requirements for these activities. Table 7-1 presents various AMD control strategies for Arctic conditions that can be found in the literature.

Table 7-1: Acid Mine Drainage Control Strategies of the Arctic (MEND 1.61.2, 1996)

Strategy	Tailings	Waste Rock
Freeze Controlled	Total or perimeter freezing options can be considered. Can freeze up to 15 m annually if freezing in thin layers. Freezing rate decreased proportionately with depth. Process chemicals could cause high unfrozen water content.	Requires considerable volumes of non-acid waste rock for insulation protection. Better understanding of air and water transport through waste rock required for reliable design.
Climate Controlled	May not be a reliable strategy for saturated tailings.	Requires control of convective airflow through waste rock, infiltration control with modest measures and temperature controls. Better understanding of waste rock air, water, and heat transport for reliable design.
Engineered Cover	Special consideration for freeze-thaw effects. Availability and cost of cover materials are major impediments.	
Sub-aqueous Disposal	Special considerations for winter ice conditions and pipeline freeze-up.	Very difficult to dispose of waste rock beneath winter ice.
Collection and Treatment	Costly to maintain at remote locations Long term maintenance cost.	
Segregation and Blending	Tailings are normally geochemically homogeneous.	May be very effective. Research and development on-going.

The concept presented in the ICRP for acid rock drainage control strategy for in-pit deposition is sub-aqueous disposal.

The concept presented in the ICRP for the acid rock drainage control strategies at Meadowbank for the TSF and RSF presented in the 2019 Meadowbank ICRP is freeze control and climate control strategies. These strategies involve placing a sufficiently thick cover of NPAG waste rock over the PAG material to provide insulation protection so that the majority of the PAG material stays frozen. The TSF and RSF cover thickness design will be different as the thermal phenomena within each facility will be different. For example, the tailings are much finer than the waste rock, which will impact the convective airflow model due to lower air conductivity and higher water content.

Freeze control strategies rely on the immobilization of pore fluids to control AMD reactions, and the potential migration of contaminated pore water outside of the storage facility. The climate conditions at the Meadowbank Gold Mine site are suitable to freeze control strategies. In addition to immobilization of pore fluids, permafrost can reduce the hydraulic conductivity of materials by several orders of magnitude.

Climate control strategies rely on cold temperatures to reduce the rate at which oxidation occurs. The low net precipitation in permafrost regions limits infiltration of water into waste rock and tailings disposal areas. Consequently, the climate of the Meadowbank Gold Mine area will act as a natural control to reduce the production of AMD.

Research activities have been undertaken since 2014 in collaboration with the Research Institute Mines and Environment (RIME) to optimize the control strategies to be used in Meadowbank for the RSF's and the TSF's. The designs of the cover of the RSF and TSF are in progress and will incorporate the results from this research. The final designs will be presented in the Final Closure and Reclamation Plan (FCRP).

Thermistors are installed in the Portage RSF and TSF North Cell to monitor thermal behavior as an adaptive management technique and to support the design of the landform cover. More information regarding thermal data and monitoring is presented in the Thermal Monitoring Plan and the Thermal Monitoring Report.

7.1 TSF COVER DESIGN

Capping trials and test pads have been constructed on the TSF North Cell in 2014 and 2015, in collaboration with the Research Institute on Mines and the Environment (RIME) to gather data that will help determine the most appropriate design for the site conditions. The design of the cover for the North Cell and South Cell has been initiated in 2015 and 2016. The design is still in progress and the final design will be presented in the Final Closure and Reclamation Plan (FCRP).

The current details for the cover system design presented in the 2019 Meadowbank ICRP are summarized below:

- The tailings cover will consist of non-acid generating material (NPAG) and ensures that the active layer remains within the cover layer. The objective for the cover system is to keep the tailings under 0°C in most conditions and to maintain saturation above 85%.
- The proposed design for the engineered cover system is a layer of compacted NPAG waste rock with a minimum thickness of 2.0 m. The nominal cover thickness over most of the landform is well over the minimum, as a thickness variation is required to obtain the designed landform and promote the water management.
- The surface water management plan for the reclaimed TSF is to minimize erosion, thus reducing suspended sediment loading to the receiving environment, and to safely convey runoff water in the event of a storm event coupled with spring snowmelt. To achieve this, the surface water management system will be constructed using riprap-lined drainage channels and riprap-lined aprons at the outlet of each catchment. The cover will have a minimum slope of 1% and be graded toward permanent drainage channels with a minimum slope of 0.5%. These drainage channels will be constructed on the cover to direct non-contact water to the environment.

A study is ongoing to advance the engineering level of the TSF cover landform with the objective of reviewing alternative concepts applicable for the closure of the TSF, reaffirming the applicability of the technology and the control mechanisms retained for the cover design. The study will also clarify the geometry of the landform with the NPAG quantities associated and define the details of the water management system required. The progress on the TSF cover

design will be presented in the next version of the Meadowbank ICRP, as well as the next steps for progressive closure. Final cover configuration and details for the TSF will be subject to modification depending on the results obtained from tailings and water geochemistry, from in-situ tests as well as from data provided from the Monitoring Program. The final TSF cover design will be presented in the Final Closure and Reclamation Plan.

7.2 IN-PIT COVER DESIGN

An 8 m water cover minimum will be maintained at closure for in-pit tailings. This will be achieved by maintaining an 8 m water freeboard from the highest tailings point to normal 3PL elevation (133.6masl) and by performing pit flooding at closure. This water cover depth will ensure that the tailings will not be re-suspended due to wave effects and ice formation and will limit access of aquatic life to it.

7.3 RSF COVER DESIGN

For the Portage waste rock storage, the current concept presented in the ICRP considers a cover of NPAG rock placed over the PAG material present in the waste rock piles. The majority of the Portage RSF was covered with NPAG material during operations. For Vault, the waste rock is mainly NPAG, and the PAG waste rock was encapsulated in the center of the pile during operations.

Based on the results of thermal modelling done so far, it is expected that the material within the RSFs will be mainly frozen after two years of placement. The use of coarse rockfill material within the waste dump will allow the development of convective cooling during winter, and insulation through trapped air within voids during summer. Given the high evaporation rate and low annual average precipitation at the site, the water infiltration into the pile is expected to be low.

The RSF cover concept consists of a 4 m thick layer of NPAG rockfill to limit the depth of the yearly active layer as part of progressive reclamation. The depth of cover was selected based on thermal modelling and instrumentation to assess the probable thickness of the active layer at closure including climate change. The NPAG cover will not be compacted during construction, but this is considered in the thermal model and in the thickness of the cover.

Additional effort will be required to verify the performance of the cover system against the design intent and inform on the final cover design. Final cover details for the RSF will be subject to modification depending on the results obtained from the Thermal Monitoring Program.

8 MONITORING AND CLOSURE

Mine closure and reclamation will utilize accepted management practices and appropriate mine closure techniques that comply with accepted protocols and standards. Closure will be based on project design and operation to minimize the area of surface disturbance, stabilize disturbed land surfaces and permafrost against erosion, and return the land to post-mining uses for traditional pursuits (MMC, 2007a). The 2019 Interim Closure and Reclamation Plan is available in Appendix 55 of the 2019 Meadowbank Annual Report.

All infrastructure associated with waste management facilities will minimize windblown dust and erosion from surface runoff, control acid rock drainage, and to enhance the re-establishment of natural vegetation and wildlife habitat. A Final Reclamation and Closure Plan will be issued in accordance with the Water License requirements.

The post-closure general concept for the Meadowbank site is illustrated in Figure 8-1. Mine waste rock storage for Portage and Vault and the tailings storage facility will be progressively closed during and after mining operations.

TSF Reclamation

The ultimate goals for reclamation of the TSF are to mitigate long-term environmental effects to the aquatic receiving environment and to establish a landform similar to that of the natural surrounding area. The TSF cover design presented in the 2019 Meadowbank ICRP is discussed in Section 7 of this plan. To monitor the long-term environmental effects of the TSF on the aquatic receiving environment, thermal monitoring and water quality monitoring are ongoing and will continue throughout closure, based on the TSF monitoring plan for the final TSF cover design.

Late in the operations period, thermal monitoring will continue to take place at the TSF using the current thermistors as well as using additional thermistors and possibly other geotechnical instrumentation installed in future years. Thermal monitoring results are and will be used to monitor how the tailings are freezing. The Meadowbank Thermal Monitoring Report contains more information about the thermal monitoring at the TSF.

Water quality monitoring also takes place at the TSF according to the Water Quality and Flow Monitoring Plan. Water quality results are and will be used to confirm the water quality in the TSF and surrounding area. Water quality results are also compared to past water quality modelling and as an input to future water quality modelling work. More information on this can be found in the Meadowbank Water Management Plan along with the annual Water Quality Forecast.

8.1 IN-PIT CLOSURE

The closure strategy for in-pit tailings deposition areas consists of pit flooding and dike breaching once the water quality is met as per the Water License requirement. Details of this strategy are presented in the Water Management Plan.

8.1.1 Pore Water Quality

The Pore Water Quality Monitoring Program will serve to characterize and monitor the chemical composition of existing IPD tailings pore water. This will be used to monitor, update, and calibrate, if required, hydrogeological and contaminant transport models previously developed. Samples are collected monthly at the mill during the first year of operation. In-situ samples were also collected in summer 2022 and 2023.

Once Goose Pit reaches full storage capacity, pore water quality will be collected directly from the in-pit tailings, once safe to do so. For more details, refer to the Pore Water Quality Monitoring Program.

8.2 RSF CLOSURE

The RSFs cover design is discussed in Section 7 of this plan. To monitor the long-term environmental effects of the RSFs on the aquatic receiving environment, thermal monitoring and water quality monitoring are ongoing and will continue throughout closure.

Thermal monitoring will continue to take place at the RSFs using the current thermistors installed at the Portage RSF as well as using additional thermistors installed in future years if required. Thermal monitoring results are and will be used to monitor the RSFs temperature as freezing progresses. The Meadowbank Thermal Monitoring Report contains more information about the thermal monitoring at the RSFs.

Water quality monitoring also takes place at the RSFs according to the Water Quality and Flow Monitoring Plan. Water quality results are and will be used to confirm the water quality in the RSFs and surrounding area. Water quality results are also compared to past water quality modelling and as an input to future water quality modelling work. More information on this can be found in the Meadowbank Water Management Plan along with the annual Water Quality Forecast.

The surrounding surfaces of the Portage and Vault RSFs will be contoured where required to direct drainage respectively to the TSF (see Figure 8-2) and towards Vault Pit (see Figure 8-3). Note that Section A in Figure 8-2 is conceptual and does not represent the completed design work of the TSF North Cell cover. The runoff water from the Vault and Portage RSFs will be monitored at closure.

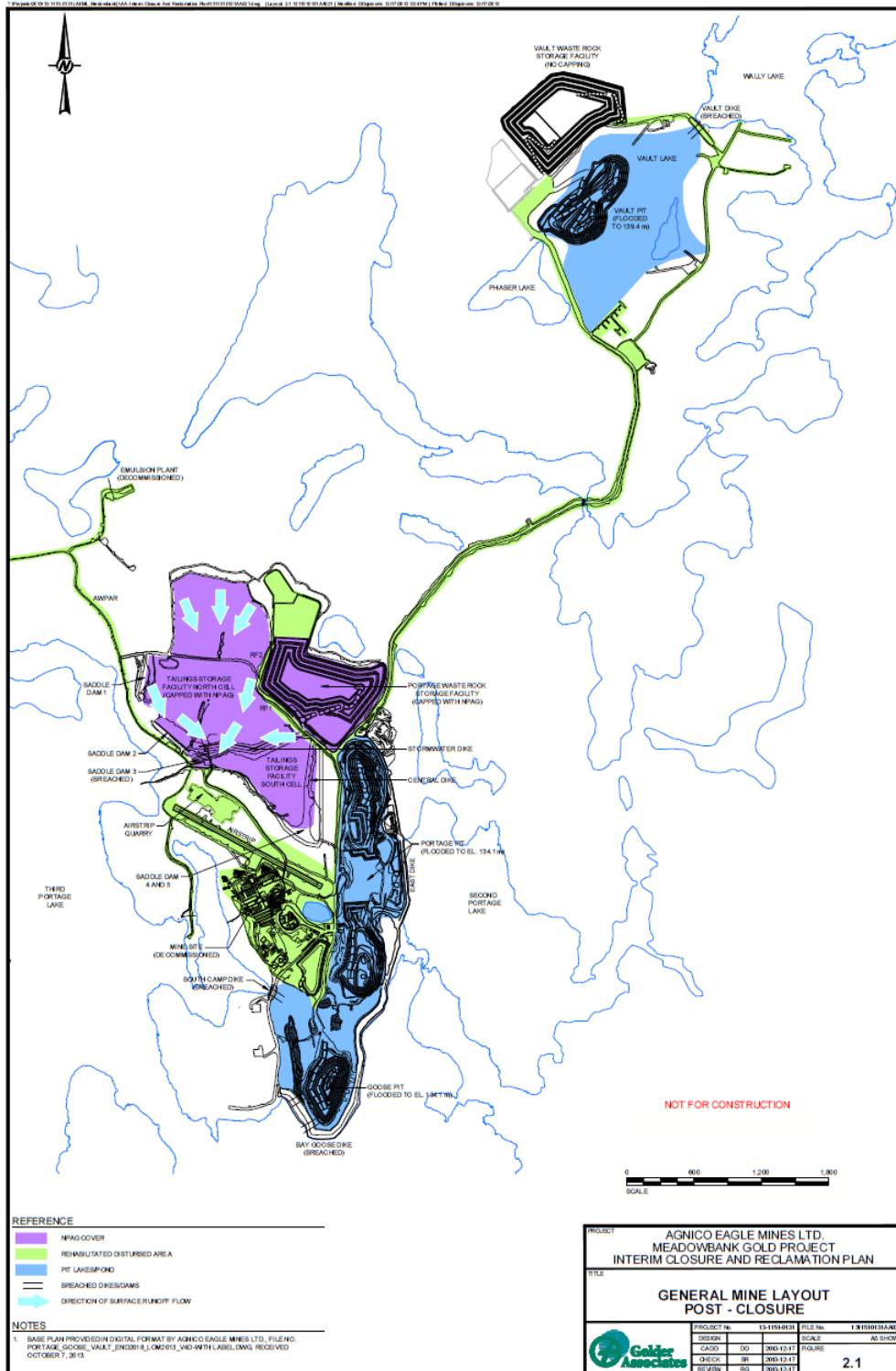

Figure 8-1: Site Post Closure Concept

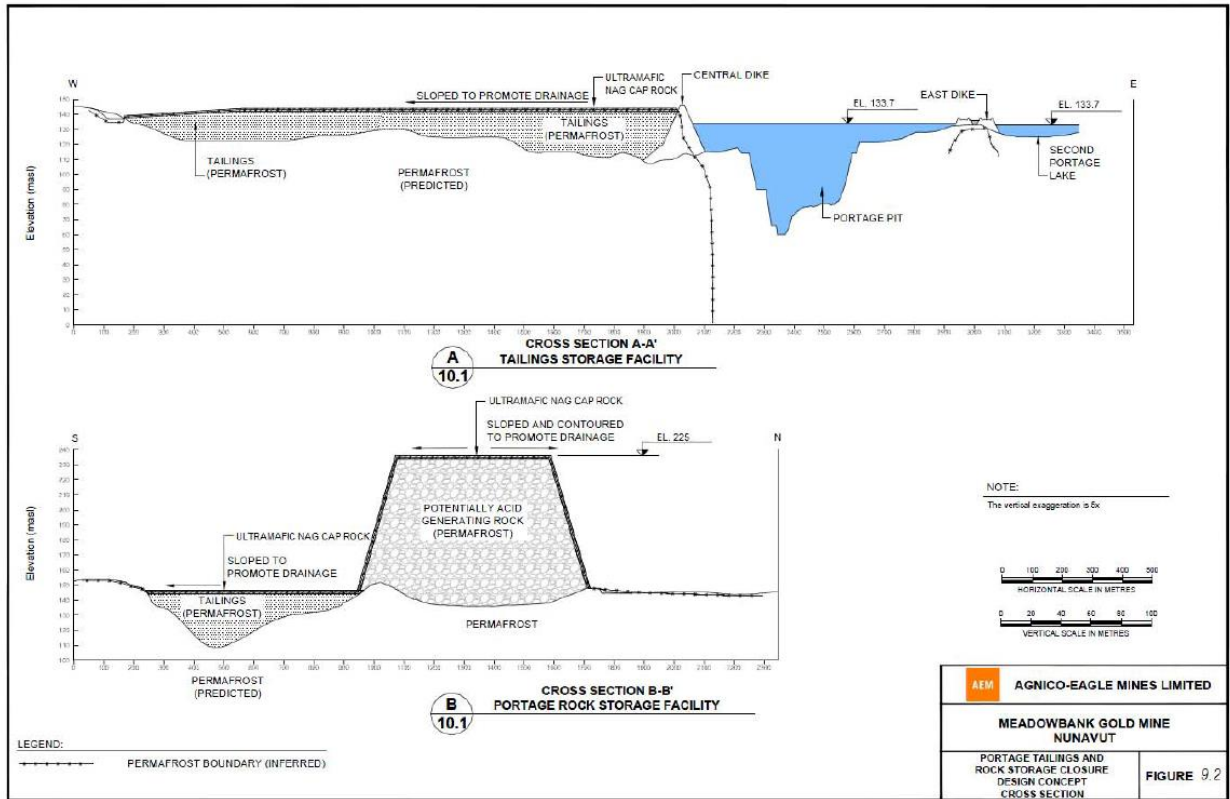

Figure 8-2: Portage Tailings and Rock Storage Closure Design Concept Cross Section

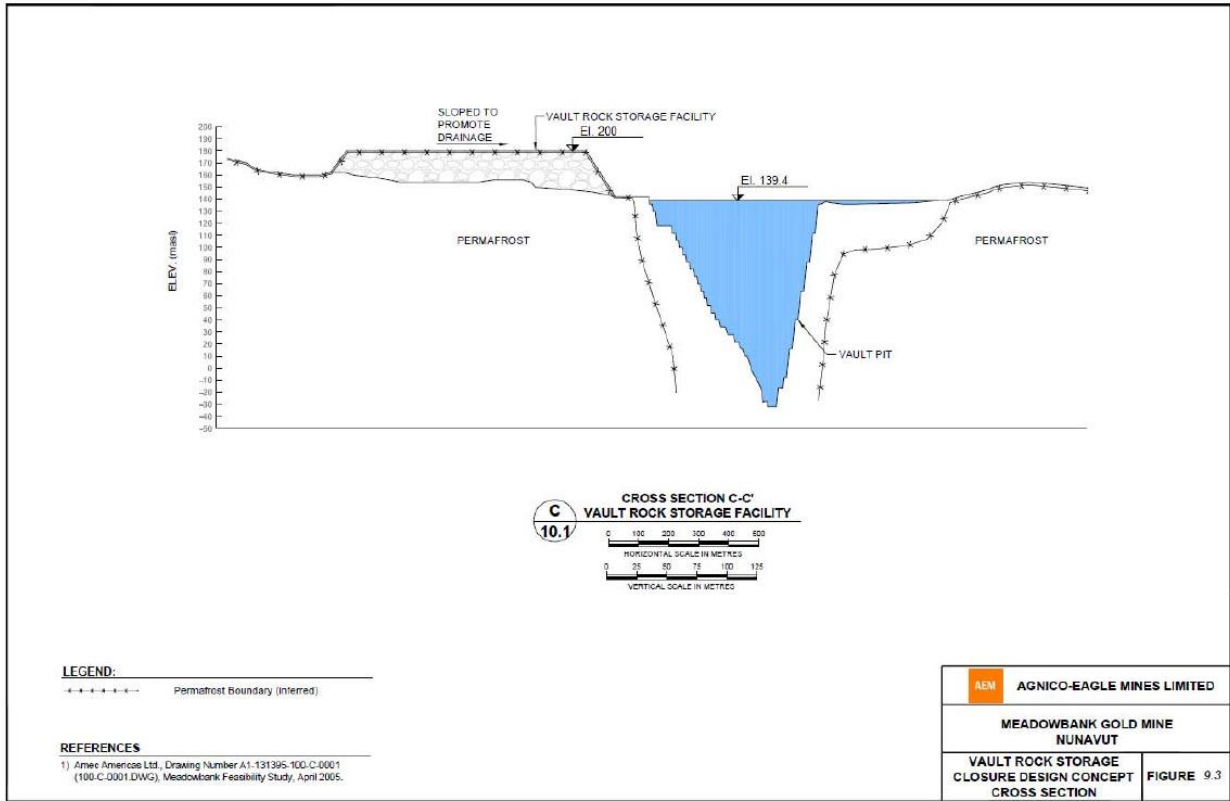

Figure 8-3: Vault Rock Storage Closure Design Concept Cross Section

9 REFERENCES

- AEM, 2013. Meadowbank Gold Project, Mine Waste Management Plan. October 2013
- Burn, C. R. 2003. Thermal modeling, Meadowbank Gold Project.
- Canadian Climate Data and Scenarios (CCDS). 2018. Online. <http://climate-scenarios.canada.ca/>
- Golder Associates Ltd. (Golder), 2008a. Coupled Thermal/Seepage and Contaminant Transport Modeling For The Tailings Facility, Meadowbank Gold Project. August 1, 2008.
- Golder Associate Ltd (Golder) 2012. Tailings Deposition Plan – Update 2012, Meadowbank Project, Doc 1344, issued in April 2012
- Golder Associate Ltd (Golder) 2014. Interim Closure, Meadowbank Project, Doc 1344, issued in April 2012
- Hayley, D. W. 2004. Climate Change – An Adaptation Challenge for Northern Engineers. The PEGG. January 2004, p.21.
- Hayley, D.W. and Cathro D.C. 1996. Working with Permafrost when Planning an Arctic Mine. CIM Edmonton 96, April 28 - May 2, 1996, Edmonton, Alberta.
- IPCC (Intergovernmental Panel on Climate Change), 2007. Climate Change 2007: The Physical Science Basis.
- IPCC. 2013. Climate Change 2013: The Physical Science Basis. Contribution of Working Group I to the Fifth Assessment Report of the Intergovernmental Panel on Climate Change. Stocker, T.F., D. Qin, G.-K. Plattner, M. Tignor, S.K. Allen, J. Boschung, A. Nauels, Y. Xia, V. Bex and P.M. Midgley (eds.). Cambridge University Press. Cambridge, United Kingdom and New York, NY, USA.
- IPCC. 2018. Global warming of 1.5°C. An IPCC Special Report on the impacts of global warming of 1.5°C above pre-industrial levels and related global greenhouse gas emission pathways, in the context of strengthening the global response to the threat of climate change, sustainable development, and efforts to eradicate poverty. V. Masson-Delmotte, P. Zhai, H. O. Pörtner, D. Roberts, J. Skea, P.R. Shukla, A. Pirani, W. Moufouma-Okia, C. Péan, R. Pidcock, S. Connors, J. B. R. Matthews, Y. Chen, X. Zhou, M. I. Gomis, E. Lonnoy, T. Maycock, M. Tignor, T. Waterfield (eds.). World Meteorological Organization, Geneva, Switzerland,
- Meadowbank Mining Corporation (MMC), 2007a. Meadowbank Gold Project Preliminary Closure and Reclamation Plan. August, 2007.
- Pacific Climate Impacts Consortium (PCIC). 2018. Online. <https://pacificclimate.org/>



APPENDIX A

Meadowbank Mined Material Balance (2009-2023)

Table A: Meadowbank Mined Tonnages for 2009

	North Portage (Tonnes)			South Portage (Tonnes)			Total (Tonnes)
	Rock	Ore	Waste	Rock	Ore	Waste	-
January	160,294	-	-	-	-	-	-
February	103,323	-	-	-	-	-	-
March	256,972	-	280	-	-	-	-
April	388,725	12,733	1,306	-	-	-	-
May	516,829	-	-	-	-	-	-
June	531,933	729	-	-	-	-	-
July	584,364	5,910	6,820	-	-	-	-
August	741,518	-	-	-	-	-	-
September	528,191	9,618	4,445	-	-	-	-
October	640,295	42,452	250	19,778	-	2,548	-
November	378,005	33,247	3,167	601,807	94,848	4,061	-
December	322,641	6,307	-	341,547	339,991	-	-
TOTAL	**5,153,090	***110,996	*16,268	**963,132	***434,839	*6,609	6,684,934
*Total Waste Rock Transferred to Waste Dump							22,877
**Total Rock Used for Construction Purposes (road, dikes, etc.)							6,116,222
***Total Ore							545,834

Table B: Meadowbank Mined Tonnages for 2010

	Portage Pit (tonnes)									Ore Processed in Mill (tonnes)
	Ore	Waste Rock								
		Dikes	Roads	Crushers	Waste Dump ¹	Landfill	Stockpiles	Other	Total	
January	97,446	223,842	190,281	156,162	173,736	-	-	-	744,021	-
February	43,979	281,368	46,654	123,727	359,649	-	32,298	1,295	844,991	47,745
March	75,333	503,299	107,635	-	197,125	23,540	-	-	831,599	163,399
April	116,940	258,416	63,100	171,451	428,814	-	-	6,196	927,977	176,857
May	136,444	258,481	10,019	148,576	672,724	-	-	50,073	1,139,873	177,610
June	152,606	534,039	24,748	126,155	401,748	-	-	12,632	1,099,322	215,389
July	236,768	471,106	176,169	127,379	237,095	-	-	-	1,011,749	193,422
August	225,467	493,626	506,385	168,085	115,930	-	-	-	1,284,026	215,559
September	272,675	503,624	606,044	161,673	214,866	5,621	-	-	1,491,828	227,502
October	232,888	235,924	595,322	56,337	461,627	53,522	-	-	1,402,832	198,394
November	247,401	3,813	104,087	8,991	963,805	-	-	-	1,080,596	218,260
December	323,641	-	299,167	8,991	1,118,767	-	-	-	1,426,925	214,400
TOTAL	2,161,588	3,767,538	2,729,611	1,257,527	5,345,886	82,683	32,298	70,196	13,285,739	2,048,537

1. Waste Rock disposed at the waste dump includes overburden stripped for exploitation of Portage Pit

Table C: Meadowbank Mined Tonnages for 2011

	Portage Pit (tonnes)									Ore Processed in Mill (tonnes)
	Ore	Waste Rock								
		Dikes	Roads	Crushers	Waste Dump ¹	Landfill	Stockpiles	Other	Total	
January	231,025	-	113,259	37,096	1,109,543	-	-	2,544	1,262,442	193,748
February	133,165	-	25,308	51,280	766,807	-	-	404	843,798	213,313
March	86,161	-	21,288	33,271	662,028	-	-	1,044	717,631	221,615
April	235,303	-	77,596	85,064	1,497,859	-	-	11,504	1,672,024	223,041
May	207,399	-	64,171	137,980	1,448,630	-	-	49,069	1,699,851	186,811
June	326,108	8,744	291,067	176,248	1,592,345	-	-	26,615	2,095,019	257,401
July	340,966	54,927	99,513	74,750	1,869,449	-	-	19,140	2,117,779	284,295
August	326,808	122,696	4,674	117,745	1,484,613	-	-	2,384	1,732,111	275,766
September	412,783	333,829	27,199	148,545	1,724,305	-	-	22,884	2,256,762	306,020
October	389,418	22,085	136,862	53,614	1,791,385	-	-	162,725	2,166,671	306,756
November	321,180	12,725	29,518	83,943	1,972,577	-	-	110,214	2,208,976	214,868
December	334,768	164,399	55,516	52,137	1,913,103	-	-	53,454	2,238,609	294,088
TOTAL	3,345,084	719,404	945,971	1,051,671	17,832,645	-	-	461,981	21,011,673	2,977,722

1. Waste Rock disposed at the waste dump includes overburden stripped for exploitation of Portage Pit

Table D: Meadowbank Mined Tonnages for 2012

	Portage Pit, Goose Pit & Vault Pit (tonnes)									Ore Processed in Mill (tonnes)
	Ore	Waste Rock								
		Dikes	Roads	Crushers	Waste Dump ¹	Landfill	Stockpiles	Other	Total	
January	312,546	-	25,347	853	1,707,100	-	-	568,896	2,302,196	275,186
February	320,370	-	57,299	-	1,859,479	-	-	276,030	2,192,808	307,134
March	311,938	-	4,574	33,835	1,760,145	-	-	374,271	2,172,825	304,740
April	318,550	-	29,748	171,964	2,187,929	-	-	183,366	2,573,007	285,702
May	253,947	37,372	200,732	103,650	2,000,982	-	-	231,500	2,574,236	320,542
June	276,731	78,343	281,403	64,460	1,866,369	-	-	226,695	2,517,270	294,829
July	354,765	9,991	342,978	134,006	1,791,752	-	-	268,051	2,546,777	337,110
August	271,444	260,083	261,459	214,516	1,327,154	-	-	720,701	2,783,914	352,831
September	364,410	674,872	515,804	7,309	1,446,572	-	-	273,284	2,917,841	313,014
October	119,100	-	488,259	-	2,163,147	-	-	590,936	3,242,342	358,860
November	133,041	6,880	281,560	7,439	2,081,931	-	-	337,974	2,715,783	356,646
December	176,287	105,724	142,448	-	2,178,832	-	-	577,195	3,004,199	314,317
TOTAL	3,213,129	1,173,266	2,631,610	738,031	22,371,392	-	-	4,628,899	31,543,198	3,820,911

1. Waste Rock disposed at the waste dump includes overburden stripped for exploitation of Portage Pit & Goose Pit

Table E: Meadowbank Mined Tonnages for 2013

	Portage Pit, Goose Pit & Vault Pit (tonnes)									Ore Processed in Mill (tonnes)
	Ore	Waste Rock								
		Dikes	Roads	Crushers	Waste Dump ¹	Landfill	Stockpiles	Other	Total	
January	184,536	-	14,052	531	2,486,541	-	-	222	2,501,346	320,729
February	196,802	-	61,036	8,913	2,495,018	-	-	-	2,564,967	329,709
March	311,380	1,520	58,325	393	2,691,265	-	-	294	2,751,797	368,323
April	271,823	317,845	79,530	77,730	2,071,408	-	-	82,810	2,629,323	309,458
May	336,532	269,930	51,645	-	2,299,765	-	-	29,650	2,650,990	363,625
June	249,724	397,170	252,710	153,310	1,443,285	-	-	494,975	2,741,450	355,498
July	330,024	54,525	16,010	111,360	2,234,897	-	-	340,655	2,757,447	368,058
August	316,136	-	92,460	145,385	2,824,875	-	-	125	3,062,845	321,294
September	307,532	-	61,465	5,940	2,774,724	-	-	98,255	2,940,384	357,595
October	353,697	-	33,470	-	2,504,101	-	-	188,000	2,725,571	377,118
November	282,046	-	35,365	-	2,637,689	-	-	-	2,673,054	300,779
December	299,298	-	18,490	-	2,073,386	-	-	125	2,092,001	370,655
TOTAL	3,439,530	1,040,990	774,558	503,562	28,536,954	0	0	1,235,111	32,091,175	4,142,841

1. Waste Rock disposed at the waste dump includes overburden stripped for exploitation of Portage Pit & Goose Pit

Table F: Meadowbank Mined Tonnages for 2014

	Portage Pit, Goose Pit & Vault Pit (tonnes)									Ore Processed in Mill (tonnes)
	Ore	Waste Rock								
		Dikes	Roads	Crushers	Waste Dump ¹	Landfill	Stockpiles	Other	Total	
January	223,588	-	-	-	1,731,954	-	-	28,475	2,187,943	364,275
February	291,542	-	-	-	1,032,536	-	-	5,554	1,876,728	314,877
March	400,472	-	246	-	1,768,995	-	-	7,891	2,681,239	303,462
April	314,088	49,640	-	98,086	1,792,686	-	-	21,683	2,598,780	355,557
May	239,028	40,939	-	40,939	1,435,491	-	-	332,704	2,673,027	339,395
June	337,659	123,348	-	123,348	1,852,273	-	-	348,606	2,573,438	356,065
July	347,514	470,324	-	470,365	1,052,263	-	-	810,414	2,650,362	361,983
August	333,746	284,388	-	284,389	1,117,766	-	-	728,531	2,602,482	341,168
September	307,532	-	-	-	1,473,602	-	-	397,963	2,431,958	354,171
October	360,860	451	-	-	1,534,790	-	-	33,932	2,214,199	308,014
November	324,971	-	-	-	1,565,615	-	-	57,065	2,265,457	349,780
December	350,972	-	-	-	1,441,827	-	-	5,447	1,960,172	369,259
TOTAL	3,831,972	969,090	246	1,017,127	17,799,797	0	0	2,778,266	28,715,785	4,118,006

1. Waste Rock disposed at the waste dump includes overburden stripped for exploitation of Portage Pit, Goose Pit, & Vault Pit

Table G: Meadowbank Mined Tonnages for 2015

	Portage Pit, Goose Pit & Vault Pit (tonnes)									Ore Processed in Mill (tonnes)
	Ore	Waste Rock								
		Dikes	Roads	Crushers	Waste Dump ¹	Landfill	Stockpiles	Other	Total	
January	386,670	240	105,275	240	1,210,880	-	382,115	328,000	2,413,420	363,485
February	319,494	-	3,836	2,894	1,340,755	-	376,732	220,739	2,264,450	304,126
March	413,718	-	164,531	15,439	1,535,819	-	79,336	246,948	2,455,791	322,865
April	326,603	-	45,986	19,698	1,701,286	-	38,059	941,986	3,073,618	301,220
May	421,329	7,743	87,127	1,155	1,550,668	-	417,637	914,675	3,400,334	358,783
June	300,844	15,732	19,602	19,438	1,654,038	-	476,220	522,338	3,008,212	359,079
July	383,427	282,843	96,679	68,334	1,447,386	-	549,248	308,208	3,136,125	353,824
August	293,046	234,032	24,069	45,617	2,149,965	-	460,273	129,812	3,336,814	361,766
September	298,214	102,009	54,488	25,549	2,675,549	-	230,741	136,669	3,523,219	280,235
October	361,340	31,103	137,850	-	2,839,411	-	156,915	-	3,526,619	354,968
November	350,347	783	11,090	-	2,438,493	-	184,551	43,385	3,028,649	358,507
December	289,204	-	84,473	7,331	2,651,063	-	-	-	3,032,071	313,994
TOTAL	4,144,236	674,485	835,006	205,695	23,195,313	-	3,351,827	3,792,760	36,199,322	4,032,852

1. Waste Rock disposed at the waste dump includes overburden stripped for exploitation of Portage Pit, Goose Pit, & Vault Pit

Table H: Meadowbank Mined Tonnages for 2016

	Portage Pit & Vault Pit (tonnes)									Ore Processed in Mill (tonnes)
	Ore	Waste Rock								
		Dikes	Roads	Crushers	Waste Dump ¹	Landfill	Stockpiles	Other	Total	
January	292,365	17,453	155,335	45,232	2,353,611	0	43,056	21	2,614,708	346,009
February	234,713	108,151	476,263	23,721	1,814,074	0	50,523	27	2,472,760	300,954
March	244,497	51,826	67,814	116,657	2,345,902	0	18,217	112	2,600,527	298,552
April	260,323	31,133	98,223	43,404	2,491,605	0	45,545	130	2,710,040	330,863
May	327,610	128,385	21,503	3,734	2,522,759	0	57,936	36,009	2,770,327	351,932
June	311,403	68,802	94,678	19,090	2,640,740	0	86,615	122	2,910,047	310,702
July	398,530	49,347	520	38,145	2,571,022	0	107,503	28	2,766,566	356,517
August	410,800	14,305	273,580	170,705	2,120,975	0	103,675	129	2,683,369	325,639
September	377,414	79,939	23,053	169,733	2,099,627	0	95,243	27	2,467,621	279,249
October	364,792		117,665	335	1,994,464	0	6,456	17	2,118,937	339,157
November	438,954	6,741	8,294	16,164	1,834,572	0	17,275	1,036	1,884,082	326,841
December	370,247	17,092	346	17,786	1,544,266	0	23,590	165	1,603,246	348,687
TOTAL	4,031,648	573,175	1,337,274	664,707	26,333,617	0	655,634	37,823	29,602,230	3,915,102

1. Waste Rock disposed at the waste dump includes overburden stripped for exploitation of Portage Pit & Vault Pit

Table I: Meadowbank Mined Tonnages for 2017

	Portage Pit & Vault Pit									Ore Processed in Mill (tonnes)	
	(tonnes)										
	Ore	Waste Rock									Total
	Dikes	Roads	Crushers	Waste Dump ¹	Landfill	Stockpiles	Other	Total			
January	386,298	45,991	0	12,301	1,498,959	0	14,815	6	1,572,073	331,889	
February	374,894	6,084	22,937	23,998	1,251,365	0	404,648	2,977	1,712,008	314,269	
March	376,855	167	8,508	12,614	919,668	0	483,332	583	1,424,872	279,684	
April	355,410	0	10,674	17,671	1,002,425	0	655,770	10	1,686,550	328,391	
May	437,319	0	135,889	84,180	933,559	0	434,648	27,889	1,616,165	344,961	
June	401,035	12,537	14,316	88,241	977,125	0	522,816	2,588	1,617,623	322,939	
July	334,363	183,868	66,559	6,647	1,016,081	0	523,311	0	1,796,466	336,222	
August	391,414	485,008	12,182	2,361	1,271,636	0	97,549	19,925	1,888,662	326,409	
September	343,504	13,148	107,454	14,945	1,246,694	0	509,366	189	1,891,796	275,754	
October	364,663	259,074	57,565	528	1,169,063	0	255,796	1,991	1,744,017	328,028	
November	321,403	21,676	653	5,395	1,406,720	0	69,651	1,362	1,505,456	330,465	
December	352,291	0	401	571	1,781,334	0		7	1,782,313	334,023	
TOTAL	4,439,449	1,027,553	437,137	269,453	14,474,629	0	3,971,701	57,528	20,238,001	3,853,034	

1. Waste Rock disposed at the waste dump includes overburden stripped for exploitation of Portage Pit & Vault Pit

Table J: Meadowbank Mined Tonnages for 2018

	Portage Pit & Vault Pit									Ore Processed in Mill (tonnes)
	(tonnes)									
	Ore	Waste Rock								
Dikes		Roads	Crushers	Waste Dump ¹	Landfill	Stockpiles	Other	Total		
January	298,411	308	8,958	1,292	1,286,572	0	378	41,538	1,637,457	290,277
February	236,865	0	83,624	27,237	1,199,432	0	251	149,036	1,696,445	288,375
March	256,063	675	5,961	22,917	1,310,619	0	1,446	165,562	1,763,243	246,416
April	225,990	56,338	440	101,881	1,228,920	0	86,609	229,113	1,929,291	254,528
May	230,283	0	50,282	0	1,198,847	0	13,831	150,173	1,643,416	301,915
June	222,227	0	3,360	0	929,405	0	1,112	119,259	1,275,363	287,319
July	190,331	0	2,918	0	681,804	0	3,196	166,296	1,044,545	347,236
August	179,509	0	7,002	0	606,678	0	661	49,324	843,174	303,191
September	210,884	0	3,482	0	609,036	0	12,180	126,692	962,274	237,935
October	174,656	0	2,510	0	494,411	0	272	118,340	790,189	239,674
November	194,071	0	1,768	0	532,824	0	336	119,821	848,820	215,299
December	204,293	0	1,066	0	508,417	0	3,392	69,652	786,820	244,500
TOTAL	2,623,583	57,321	171,371	153,327	10,586,965	0	123,664	1,504,806	15,221,037	3,256,665

1. Waste Rock disposed at the waste dump includes overburden stripped for exploitation of Portage Pit & Vault Pit

Table K: Meadowbank Mined Tonnages for 2019

Month	Portage Pit & Vault Pit (tonnes)								Ore Processed in Mill (tonnes)
	Ore	Waste Rock							
		Dikes	Roads	WRSF	Backfill	Stockpiles	Other	Total	
January	144,114	86	565	39,778	140,693	269	96,170	277,561	251,914
February	111,814	0	435	24,953	148,716	83	39,017	213,204	208,736
March	120,143	0	131	3,641	256,068	0	3,682	263,522	176,931
April	100,456	0	9065	22,390	169,688	296	52,685	254,124	213,095
May	83,237	0	20,906	15,132	76,700	0	0	112,738	191,880
June	46,290	0	7,766	12,490	99,907	8,265	0	128,427	224,028
July	44,584	0	348	6,873	49,797	0	24,795	81,813	334,437
August	55,282	0	9,244	9,803	95,245	696	110,604	225,592	70,519
September	10,965	0	348	0	49,961	174	2,436	52,919	0
October	30,659	0	1,974	2,233	15,498	336	462	20,503	6,280
November	0	0	1,680	0	0	0	0	1,680	119,445
December	0	0	0	0	0	0	0	0	6,091
TOTAL	747,544	86	52,461	137,293	1,102,273	10,118	329,851	1,632,083	1,803,356

Table L: Meadowbank Mined Tonnages for 2020-2023

		2020	2021	2022	2023
Portage Pit	Total Waste Rock (t)	0	0	0	0
	<i>NAG (~ %)</i>	N/A	N/A	N/A	N/A
	<i>PAG (~ %)</i>	N/A	N/A	N/A	N/A
	Till (t)	0	0	0	0
	Ore (t)	0	0	0	0
Vault Pit	Total Waste Rock (t)	0	0	0	0
	<i>NAG (~ %)</i>	N/A	N/A	N/A	N/A
	<i>PAG (~ %)</i>	N/A	N/A	N/A	N/A
	Till (t)	0	0	0	0
	Ore (t)	0	0	0	0
BB Phaser Pit	Total Waste Rock (t)	0	0	0	0
	<i>NAG (~ %)</i>	N/A	N/A	N/A	N/A
	<i>PAG (~ %)</i>	N/A	N/A	N/A	N/A
	Till (t)	0	0	0	0
	Ore (t)	0	0	0	0

Note: Difference between pit mill feed and total mill feed is due to stockpiled material to be processed.

Table M: Waste Rock Mined Compared to FEIS Prediction

	Portage/Goose			Vault		
	Non-PAG	Uncertain	PAG ¹	Non-PAG	Uncertain	PAG ¹
FEIS Estimated Quantity (10 ⁶ tonnes)	64.3	8.9	28.8	51.0	7.5	9.5
Mined Quantity (10 ⁶ tonnes)	54.0	0	91.5	54.0	0.0	23.7

¹ PAG quantity includes ORE for Mined Quantity



APPENDIX B

TSF and Pits Integrated Tailings Deposition Plan

2024 IN-PIT TAILINGS OFFICIAL DEPOSITION PLAN – ANNUAL REPORT

MEADOWBANK

PLAN UPDATE : January 2024

TABLE OF CONTENTS

- **Introduction**
- **Parameters and Assumptions**
 - Tailing properties
 - Annual Water Objectives
 - Water Transfers
- **2024 IPD Deposition Plan**
 - Current State – Jan 2024
 - Deposition Schedule
 - Ore Throughput
 - Water Level Projection
- **Path Forward**
 - Risks & Opportunities



Meadowbank – Aug 2021



INTRODUCTION

- IPD Plan Objectives
 - Provide global construction schedule update
 - Identify deposition needs
 - Identify infrastructure moves
 - Identify water transfer requirements
 - Set reclaim requirement
 - Update plan based on current parameters
 - Minimise freshwater consumption
- Deposition Plan modeling steps:
 - *Yearly from 2024-2026Q2*
- Starting water balance & surfaces: Jan 2024
- MinePlan : 20221122_23BUD_Sc2C

IN-PIT DEPOSITION - 2024 INFRASTRUCTURE OVERVIEW



AGNICO EAGLE

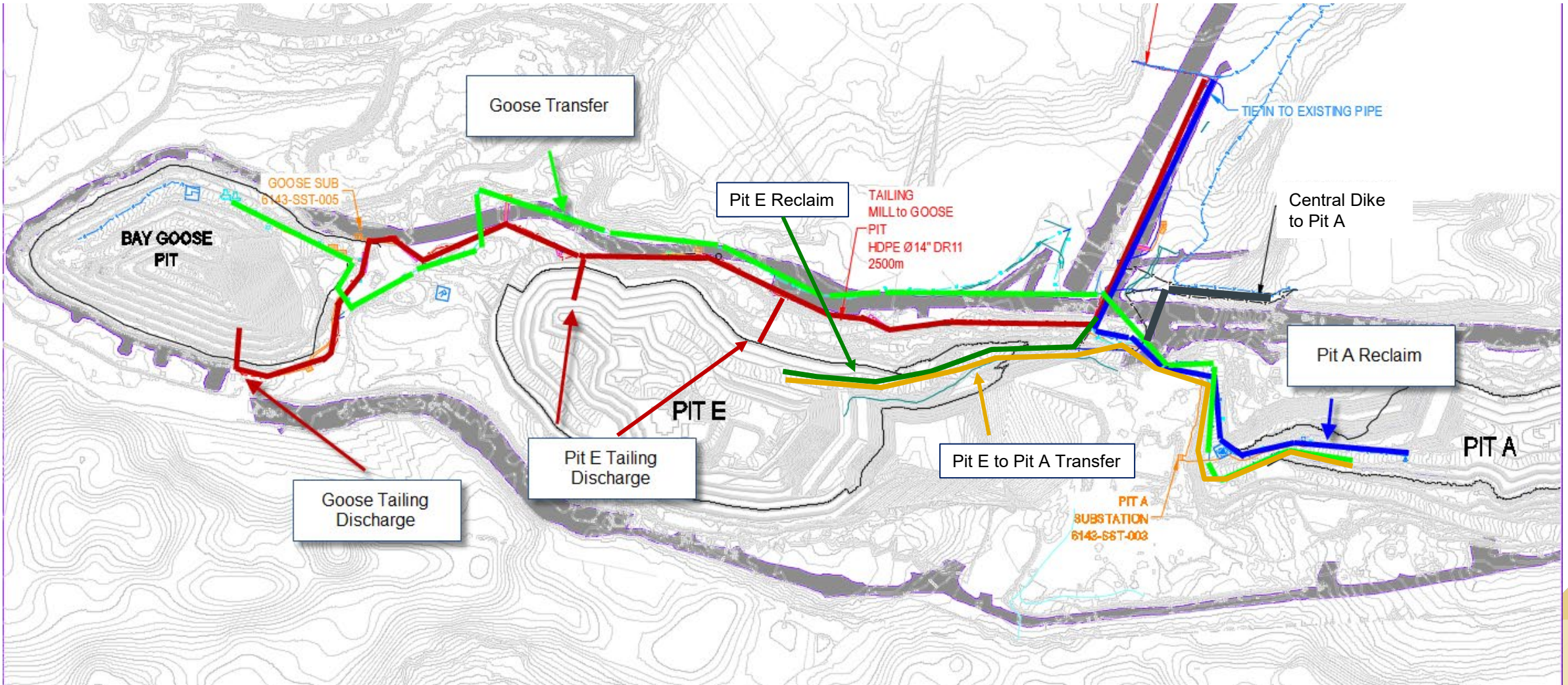

IPD 2024 PLAN – PARAMETERS AND ASSUMPTIONS



Parameter	Unit	Value	Source
Slope Angle - Pit	%	0.63 (65), 6.52 (200m), 1.02 (90m)	Bathymetry
Dump Porosity	%	30	Assumption
Slurry Density	t/m ³	1.59	Historical (2023)
In situ Density	t/m ³	1.54	Bathymetry
Water Entrapment	%	48	Calculation
Mill Water consumption	m ³ /t	1.00	Historical (2023)
Fresh Water Intake	m ³ /t	0.20	Historical & Projection

2024 WATER OBJECTIVES



Objective	Target 2024
Fresh Water Withdrawn from 3PL (Mill + Camp)	839,664 m ³
Contact Water withdrawn from Pit E (Reclaim to Mill)	3,375,425 m ³
Fresh water per tonne ore processed	0.20 m ³ /t
Treated Water Discharge	0 m ³
Water Discharged (East Dike to 2PL)	61,000 m ³
Water in Recirculation (Water recycled / total water use)	0.80

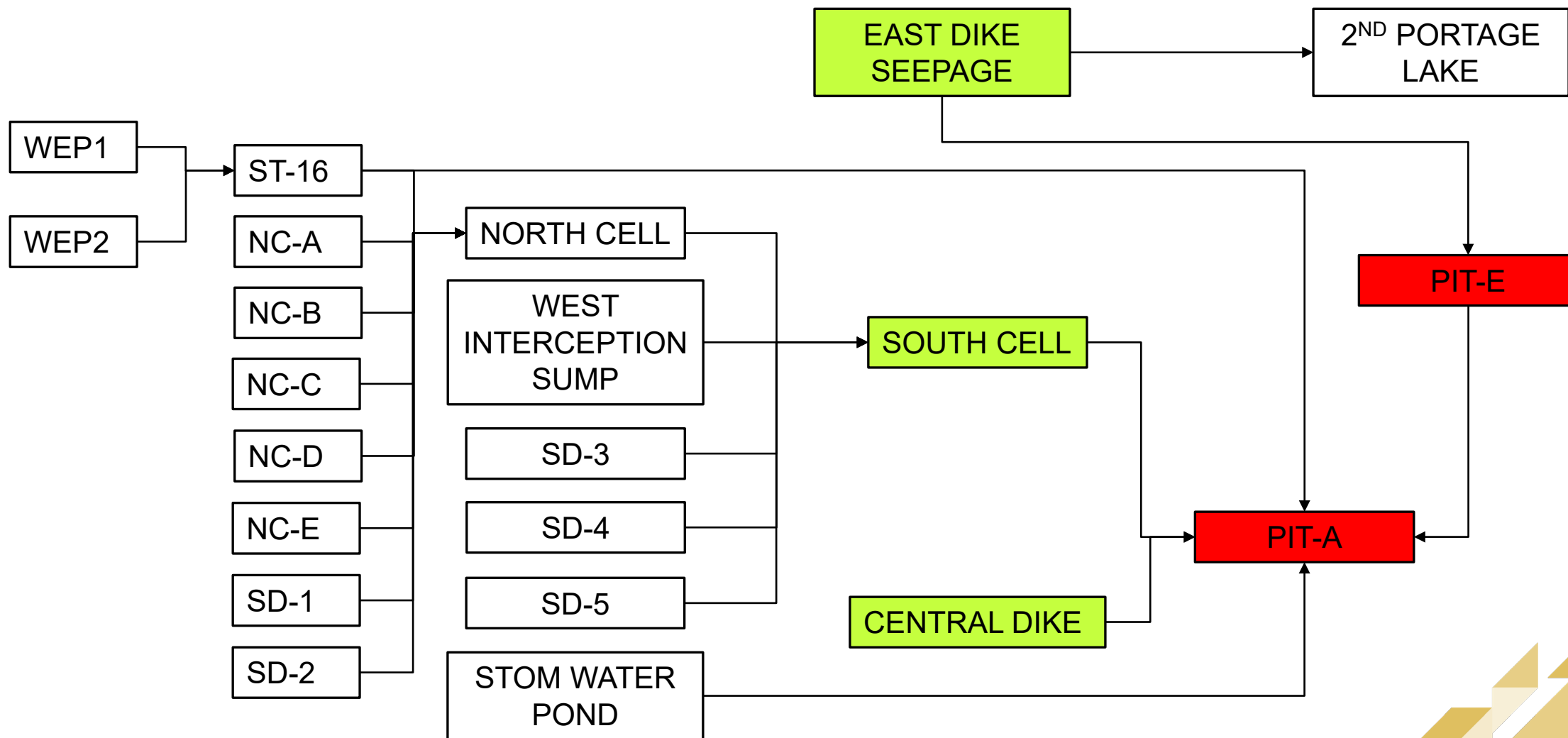

IPD 2024 PLAN – JAN 2024 START POINT



AGNICO EAGLE

Current Water Elevations:

	Pit A (masl)	Pit E (masl)	Goose (masl)
Actual – Jan 2024	101.56	93.41	118.28
Plan - Jan 2024	99.19	93.64	119.62

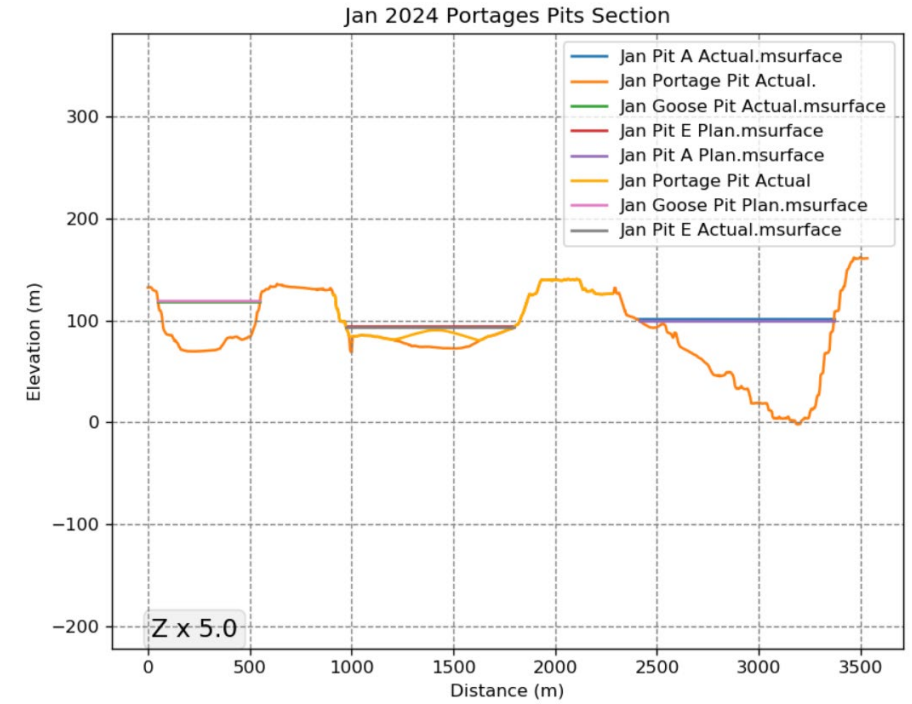

IPD 2024 PLAN – DEPOSITION SCHEDULE



AGNICO EAGLE

2024 IPD Deposition Location Schedule

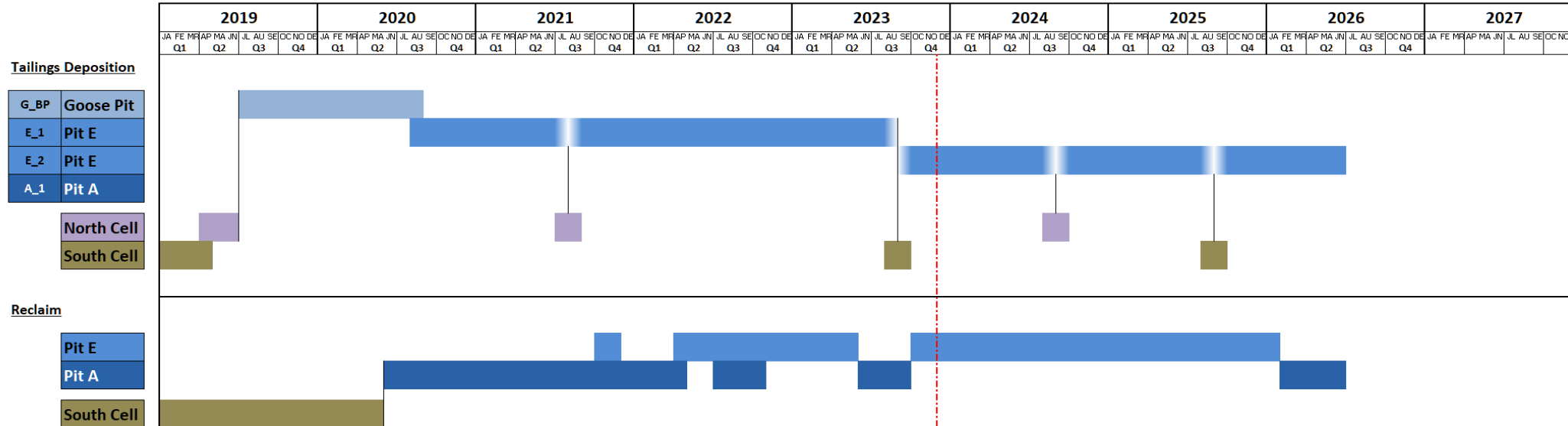

- Tailings Deposition: Pit E
- Reclaim from: Pit E & Pit A
- Water Transfer: Pit E → Pit A
 - Stops in summer from 2023-2024, and none past 2025
- No Goose Pit transfers planned

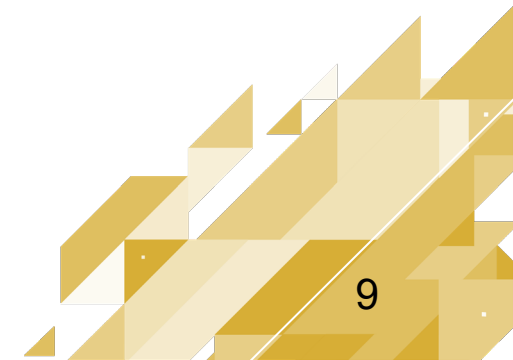

PLANNED 2022BUD SC2 MILL THROUGHPUT



Year	Ore Mined - Total	Ore Processed	Production Days
	(t)	in Mill (t)	
2017*	0	0	-
2018*	46,149	0	
2019*	1,140,323	2,750,306	214
2020*	3,032,794	2,602,827	366
2021*	4,065,016	3,570,491	365
2022*	4,347,778	3,965,197	365
2023	3,420,237	4,315,607	365
2024	4,909,300	4,301,272	366
2025	5,023,586	4,100,980	365
2026	0	2,338,080	365

IPD 2024 PLAN – Q4 2024

Forecast In-pit results

Location	Tailings Discharge (t)	Tailings Elev (masl)	Water Elev (masl)
Goose	0	89.87	122.51
Pit E	3,848,220	89.14	99.69
Pit A	0	0.00	109.59

Mill Water Consumption

Source	Origin	Volume (m ³)	Average flow m ³ /h
Reclaim Water	Pit E	3,375,425	385
Fresh Water	Third Portage Lake	804,894	92

Notes:

- Deposition occurs in Pit E
- Reclaim from Pit E
- Pit E Water Level Portage Pits connection at 86.5
 - Water will overflow to Pit E through Central Dump



MBK – Plan View



AGNICO EAGLE

IPD 2024 PLAN – Q4 2025

Forecast In-pit results

Location	Tailings Discharge (t)	Tailings Elev (masl)	Water Elev (masl)
Goose	0	89.87	125.19
Pit E	3,816,014	96.02	108.54
Pit A	0	0.00	113.53

Mill Water Consumption

Source	Origin	Volume (m ³)	Average flow m ³ /h
Reclaim Water	Pit E	3,354,466	383
Fresh Water	Third Portage Lake	799,776	91

Notes:

- Deposition occurs in Pit E
- Reclaim from Pit E
- Pit E Water Level Portage Pits connection at 86.5
 - Water will overflow to Pit E through Central Dump

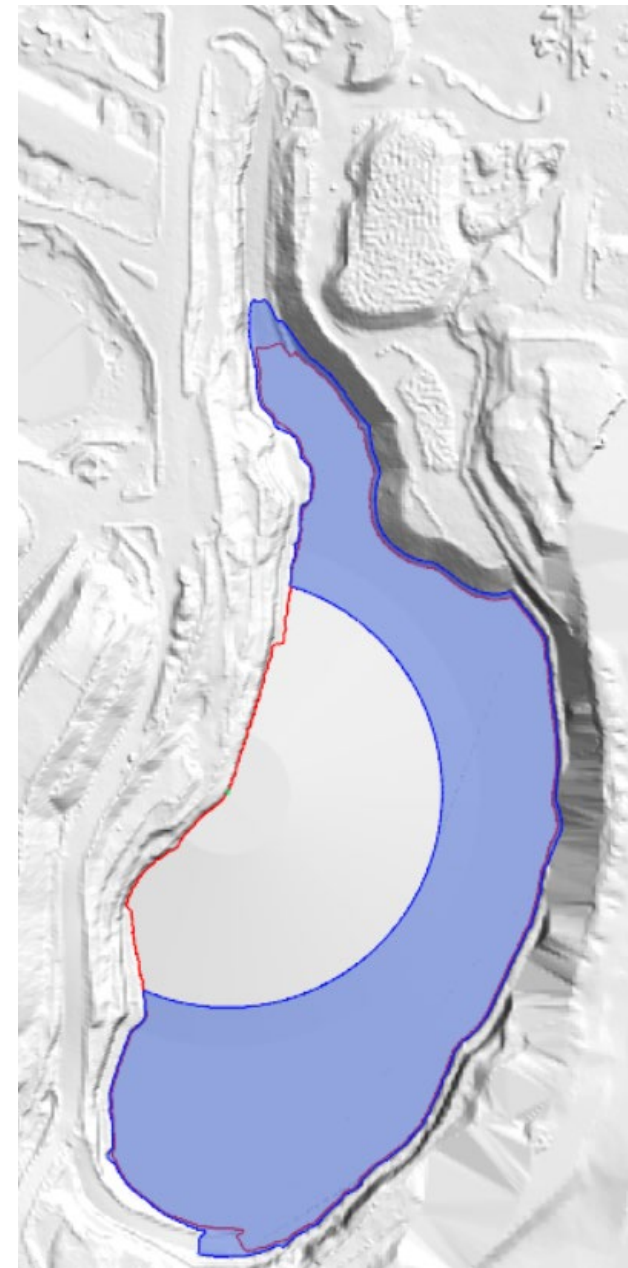

MBK – Plan View



AGNICO EAGLE

IPD 2024 PLAN – Q2 2026

Forecast In-pit results

Location	Tailings Discharge (t)	Tailings Elev (masl)	Water Elev (masl)
Goose	0	89.9	126.41
Pit E	2,115,627	99.83	114.89
Pit A	0	0	112.12

Mill Water Consumption

Source	Origin	Volume (m3)	Average flow m3/h
Reclaim Water	Pit E	1,700,938	194
Fresh Water	Third Portage Lake	405,930	46

Notes:

- Deposition occurs in Pit E
- Reclaim from Pit A
- Pit E Water Level Portage Pits connection at 86.5
 - Water will overflow to Pit E through Central Dump



MBK – Plan View



AGNICO EAGLE

NC/SC 2024 PLAN - 2024

Forecast NC/SC results

Location	Tailings Discharge (t)
NC	350,100
SC	0

Parameter	Unit	Value	Source
Slope Angle - NC	%	0.54 (100), 0.43 (150m), 0.43 (200m)	Bathymetry

Notes:

- North Cell will have deposition during the month of August in 2024, while the rest of the year is going to be in-pit deposition.
- Additionally, deposition will serve as a method to suppress any potential dust generation in the cell in the future.

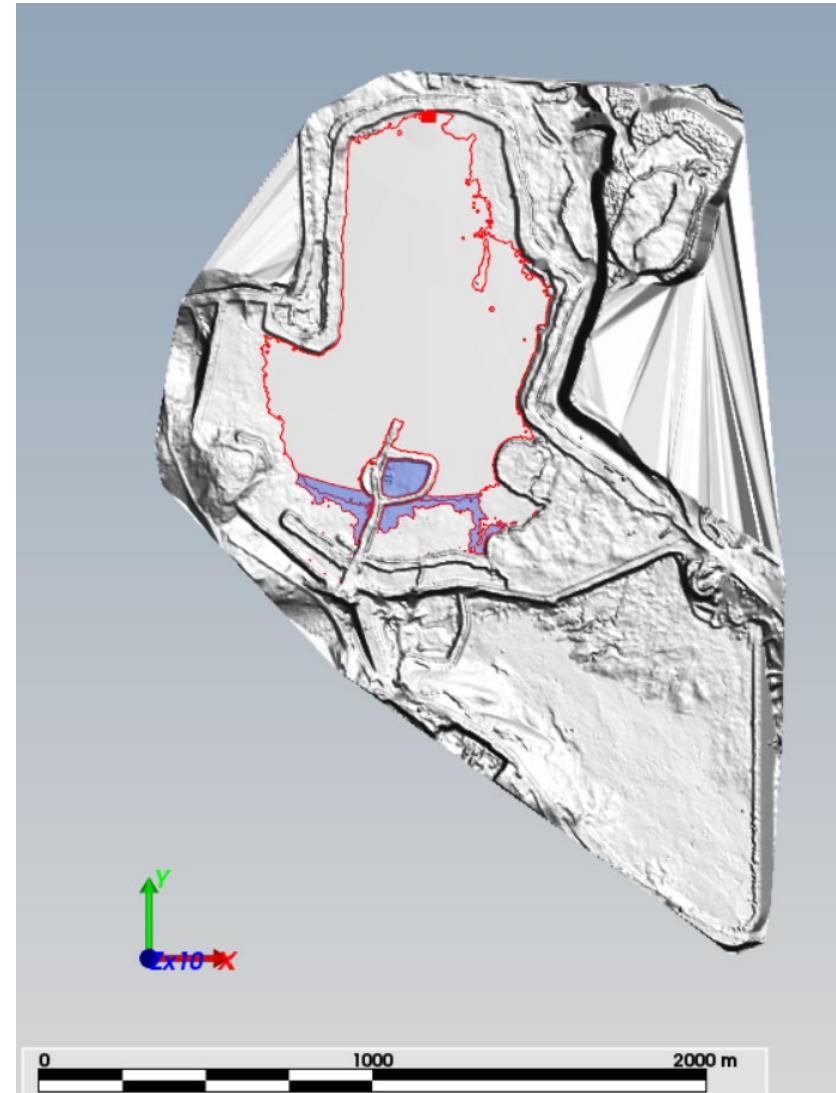

MBK – Plan View

NC/SC 2024 PLAN - 2025



AGNICO EAGLE

Forecast NC/SC results

Location	Tailings Discharge (t)
NC	0
SC	356,040

Parameter	Unit	Value	Source
Slope Angle - SC	%	0.20 (100), 0.30 (100m), 0.42 (200m)	Bathymetry

Notes:

- South Cell deposition during the month of August in 2025, while the rest of the year is characterized by in-pit deposition.

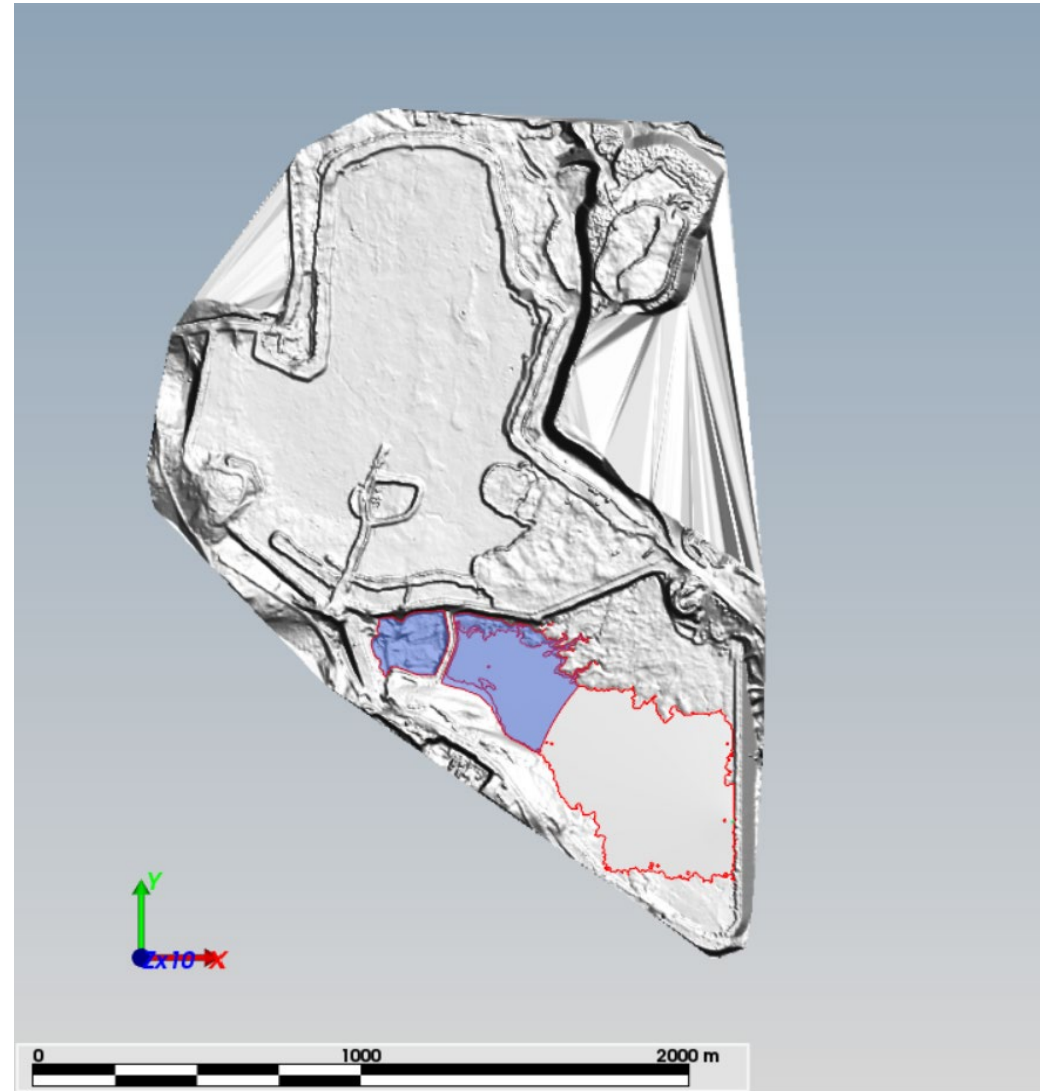

MBK – Plan View

IPD – WATER LEVEL PROJECTION



Pit A & Pit E - Water Level Forecast

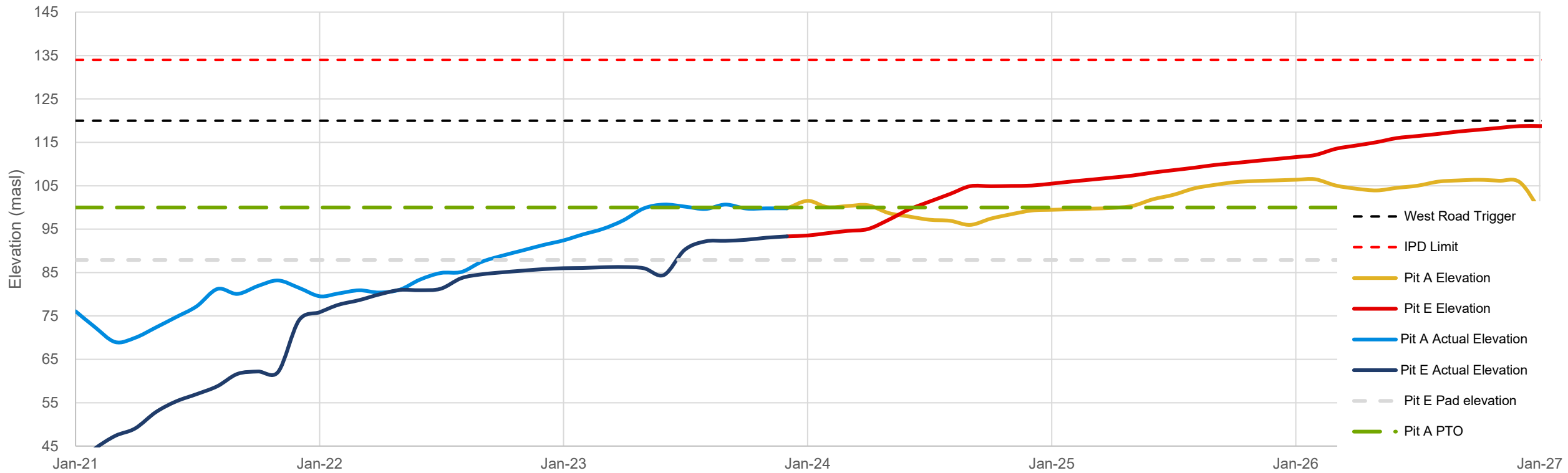

RISKS AND OPPORTUNITIES



Risks

- Model does not account for wet years or flood events
- No contingency for difficulties operating the reclaim system at maximum performance

Opportunities

- Reduce closure costs and enhance dust suppression at North/South Cell with additional tailings deposition
- Improve freshwater consumption to beat the 0.20 m³/t target – reduce water sent to Portage Pits
- Minimize infrastructure movement required for deposition

THANK YOU

